

# 40' x 160' Pole Tent Safety & Set Up Guide



2350 East Mason St, Suite 8, Green Bay, WI 54302 | 920.431.0938 | sales@americantent.com | www.americantent.com

Thank you for your purchase from American Tent. The following procedures will help you through your installation. If you ever run into problems with the installation of your American Tent, give one of our sales/service professionals a call at 920.888.4053. Other product specific information, contact information, diagrams, and installation guides are available on our web site: [www.americantent.com](http://www.americantent.com).

## INDEX

Page 1.....	Tent & Equipment
Page 2.....	Safety & Maintenance
Page 3.....	Diagram
Page 4.....	Set Up
Page 7.....	Additional Assembly
Page 8.....	Striking
Page 9.....	Terms & Conditions

## REQUIRED EQUIPMENT

Sledge Hammer



8 Drop Cloths



4-6 People



2 Measuring Tapes



## PROVIDED EQUIPMENT

18' Center Pole (7x)



7' Side Pole (40x)



Stake (78x)



Ratchet (78x)

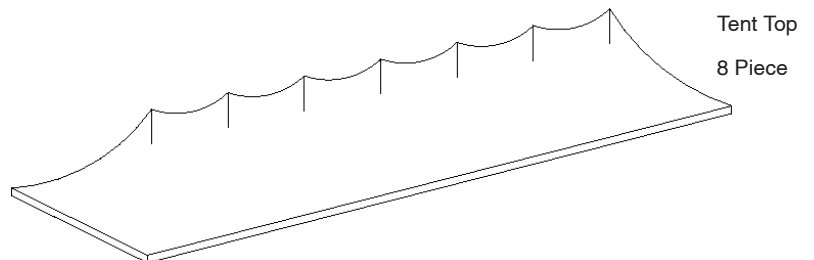

Tent Top

8 Piece

QR Codes are shown throughout these instructions. These codes are links to helpful YouTube videos produced by American Tent to assist you in various steps of setup. The code provided links to a general overview on setting up your pole tent

Pole Tent Setup



# Weather

Weather is very unpredictable; the installer or end user must use their judgment, common sense and knowledge of conditions. The installer is responsible for anticipating weather severity for proper time and method of installation. *If inclement weather is predicted with winds that exceed 36 mph with gusts of more than 6 seconds the tent needs to be evacuated and guests directed indoors. This type of weather can lead to the tent becoming structurally unsafe. Please remember, this is a temporary, non-engineered structure.*

## The end user should be mindful of the following conditions:

### Wind

Wind can cause the tension of the tent to change by loosening ratchet assemblies, pulling stakes, or causing poles to shift or sink. It is important to do routine maintenance checks and maintain proper tension on the tent top at all times.

Additionally, to prevent damage such as rips or tears, consider disassembling your tent or safely removing your tent top if wind speeds reach 25 mph for more than 6 seconds. Persistent winds at this speed can stress the fabric, potentially leading to damage. We recommend taking the tent down under such conditions to keep your tent in pristine condition, use after use.

### Rain

Water can collect on the tent fabric causing ‘ponding’ under certain conditions, especially if the tent is not installed & tensioned correctly. Ponding can destroy the tent fabric & cause poles to sink into the soil. Additionally, saturated soil can cause stakes to lose their holding power.

### Lightning

It is very dangerous to be under a tent during a lighting storm. Immediately leave the tent until the chance of lightning is no longer present.

### Snow

Tents are not designed to carry any type of snow loading. This product should not be used if snow has been allowed to accumulate.

## Site Selection

**CRITICAL:** Before staking, contact your local utility 811 number and have the site checked.

*Scan the QR code to find your local number.*



### Look carefully at the factors below when selecting a site:

- Soil Conditions**– Adequate for anchoring
- Location**– Elevated, level, and clear of debris
- Space**– Check perimeter for space to anchor the tent
- Surface**– Grass, Gravel, Concrete, Asphalt, Wood
- Site Access**– Services and delivery can easily be achieved
- Check Overhead**– Look for any electrical lines or tree branches
- Underground Utilities**– Utilities must be located.

*Use the 811 service to schedule a utility locate. If staking, be aware of underground electric, gas, oil, steam, telephone, CATV, water, sewer services. Have the site checked prior to staking.*

**Weather**– Monitor for weather conditions and evacuate if necessary

**Emergency Exits**– Easily accessible exit routes in case of emergency

## Fire Safety



Our tents come with a tag confirming this product is manufactured using flame-resistant fabric that **meets or exceeds NFPA-701-2**

### Safety Checklist:

- When building or assembling anything above shoulder height, wear a hard hat
- Steel toe boots are recommended
- Inspect the site– look for overhead and underground obstructions
- Call your local utility to have the area marked ahead of time
- Inspect all ropes and tie lines and replace/repair as needed
- Inspect all poles and fittings to make sure there are no bends or breaks
- Replace or repair any items in poor condition
- CALL 8-1-1 BEFORE DOING ANY STAKING**

The installer must follow local building codes and fire regulations, and evaluate the site for proper securing and anchoring for the conditions.

# 40x160 Pole Tent Poles and Anchoring



2350 East Mason Street, Suite 8, Green Bay, WI 54302 | 920.431.0938 | sales@americantent.com | www.americantent.com

## POLES

7x  18' x Ø 3" Center Pole

40x  7' x Ø 2" Side Pole

## STAKE & BOLT ANCHORING

78x  Ratchet Strap  
KIT-RAT-2N

78x  Eye Bolt & Concrete Anchor  
AMT-KIT-FRT-CON

1x  Eye Bolt Set Tool  
AMT-KIT-FRT-CON

---OR---

78x  Ratchet Strap  
KIT-RAT-2N

78x  Stake  
PUR-STK-STD

## POLE LAYOUT

All units are in feet

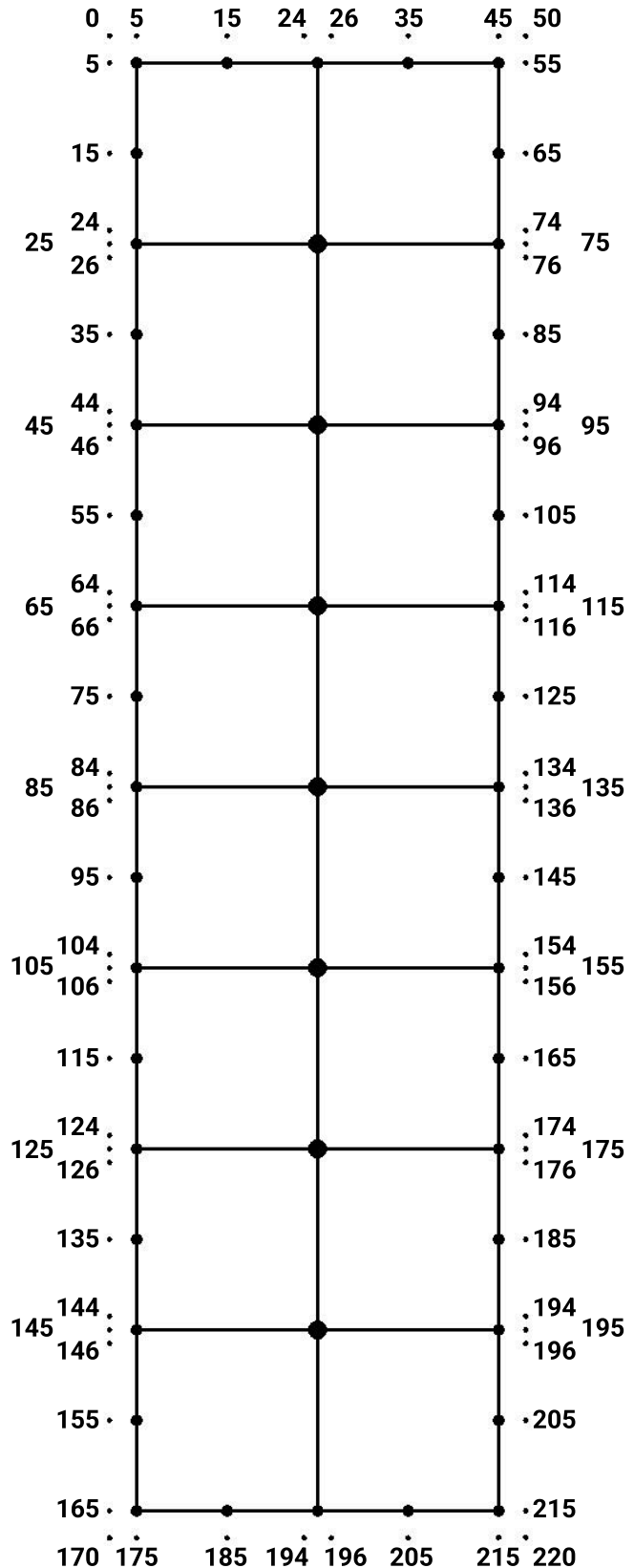

# SET UP

Please know that your safety is our priority. Before setting up your tent, be sure to confirm with your utility locating service (8-1-1) that it is safe to set up your tent in your desired location. Be aware of potential weather conditions, and always evacuate your tent during periods of extraordinarily high winds or lightning.

1. **Check the parts list to make sure every part is present and accounted for**
2. **Squaring the stake line---After getting your space marked by the utility locator service you will need to square and mark your stake lines**
  - a. Use the "0" end of two tape measures and anchor them in to the ground at the first corner of the stake line. Call it Point A.
  - b. Take the first tape measure (Tape 1) and draw it out to the 50' and anchor Tape 1 into the ground. Call this Point B.
  - c. Take Tape 1 and add 170' existing width dimension and turn 90 degrees. Draw the tape measure out to that measurement.
  - d. Taking the second tape, Tape 2, already anchored at position A and draw it out to the diagonal measurement of 177'2". Where this measurement and the Tape 1 intersect is Point C
  - e. Anchor Tape 1 into the ground at Point C then draw out Tape 2 to 220' and anchor at Point C.
  - f. Take Tape 2 and draw it toward Point D stretching Tape 2 tight and anchoring it to the ground at 170', Point D, the remainder of Tape 2 should be pulled to the anchor at Point C.
  - g. After squaring the tent, go back through and mark the positions of all the poles and stakes.  
(Reference Page 3)

3. **Lay the parts out in the approximate position they will be in once tent is up**

## Lay Out The Parts

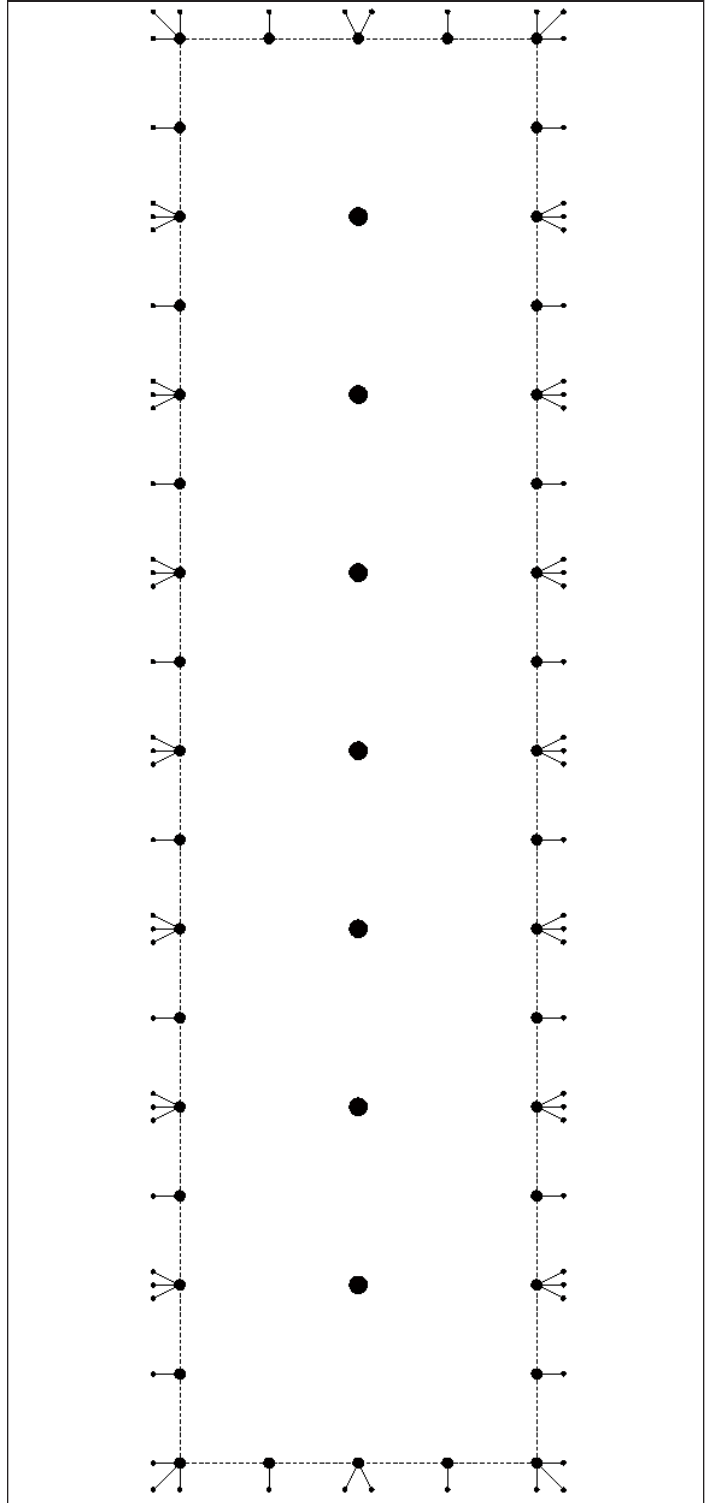

## Squaring- Measurement Marking A

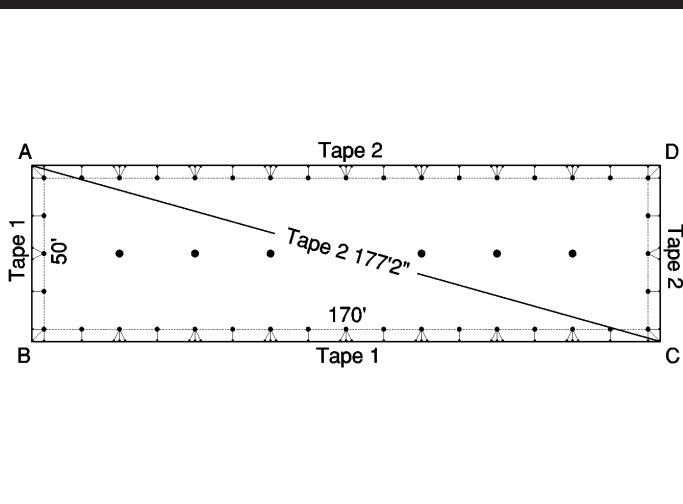

# ANCHORING

There are two recommended options for anchoring your pole tent - stakes or concrete anchors.

## Staking

### Drive stakes vertically at all points indicated

Stakes should have 6" or less of the head exposed. The deeper the stake is driven, the better the holding strength. Stakes driven vertically have better holding strength than stakes driven at an angle.

### Proper Staking

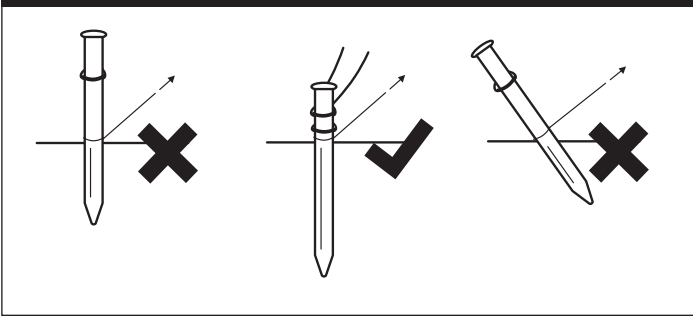

## Concrete Anchor Kit

1. Using a hammer drill with a 3/4" masonry bit, drill a hole in the same location you would normally put a stake. The anchor should be placed at a minimum depth of 1-1/4".
2. Remove all dust and debris from the hole with a vacuum or compressed air.
3. Place the anchor into the hole and set the anchor with an anchor setting tool and a hammer.
4. When the anchor is set to the correct depth, thread the eye bolt in.
5. Pull loop end of the strap through the eye bolt. Take the other end of the strap and pull it all the way through the loop. Pull the long end tight to secure the strap to the eye bolt.

## Concrete Anchoring

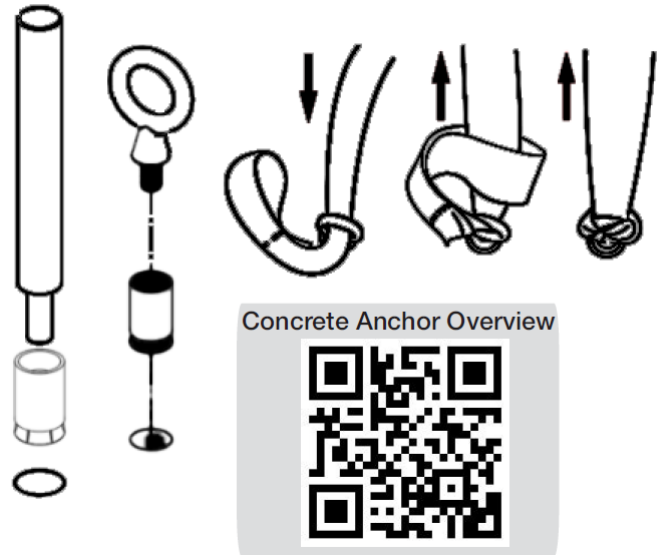

# RAISING THE TENT

Spread a drop cloth on the ground to protect the tent top from dirt and abrasions; open tent top on drop cloth

## 1. If your tent is sectional, lace your tent

- Line up each section (lace at bottom) so they overlap
- Starting in the middle, pull first lace up through first small grommet. Pull second lace up through second grommet and then pull through the loop of the first lace and so on.
- Use the velcro-like fabric to close rain flap
- Tie off to secure whole lace line
- Connect velcro-like material located on valance section at end of each lace line
- Repeat to secure all other lace lines

### Lacing

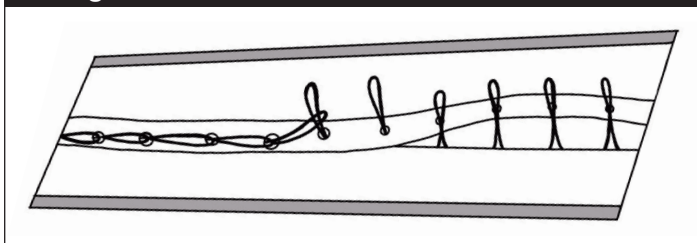

## 2. Choke ratchets to stakes Loosely (tail ends)

### Ratchet to Stake

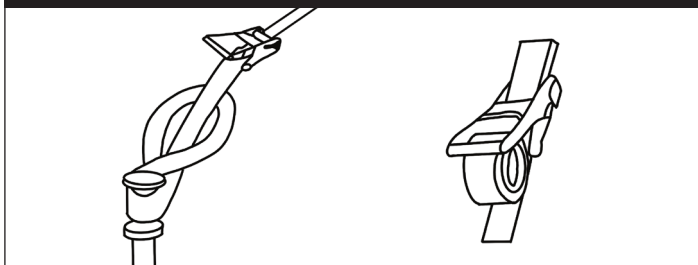

## 3. Choke ratchets to rings on tent top (handle sides) Loosely thread the tail into the ratchet

- Raise side poles starting at a corner working toward the adjacent corner on the short side of the tent. Place pole bottom 5' from stake. Raise poles until slightly less than perpendicular and the pole top is leaning in 1'-2'. Attach and tie jumper lines as side poles are installed. (Reference "Pole Tilt" diagram)

### Pole Tilt

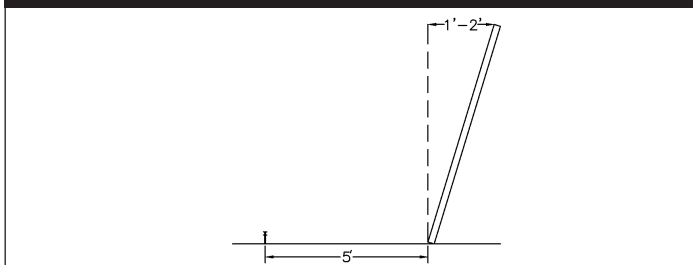

## 5. Raise center poles, starting with the upwind pole

## 6. Guide center pole pin through the grommet being careful not to damage the fabric of the tent top

## 7. Tie center pole jumper ropes as poles are placed

- Create a loop and toss 1-3' from the tent top
- Pull down to tighten the loop
- Take the rope at chest height, wrap and tie as the picture shows

### Jumper Ropes Attachment

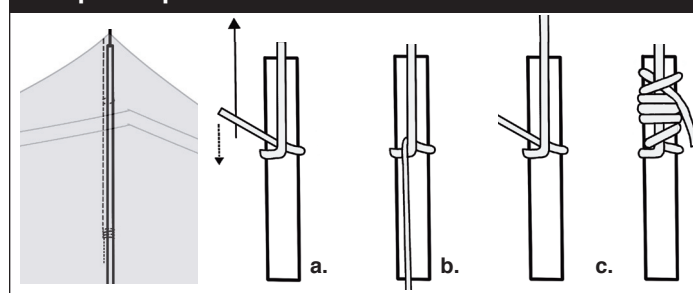

## 8. Check and position center poles, corner poles and side poles to exact locations on the marks from step 2

## 9. Starting with the four corners tighten ratchet straps until all the poles are perpendicular. Move onto the side poles and repeat.

## 10. Congratulations! It's a tent!

### Jumper Lines



### Lacing



# ADDITIONAL PRODUCT ASSEMBLY

## SIDEWALLS

1. Carefully unfold the sidewall so that it is a long, fan folded piece
2. Pick up the sidewall and carry on one shoulder while clipping every third clip with the opposite arm
3. Make sure the open side of the clips are facing in towards you
4. Once every third clip has been attached, go back and clip the rest

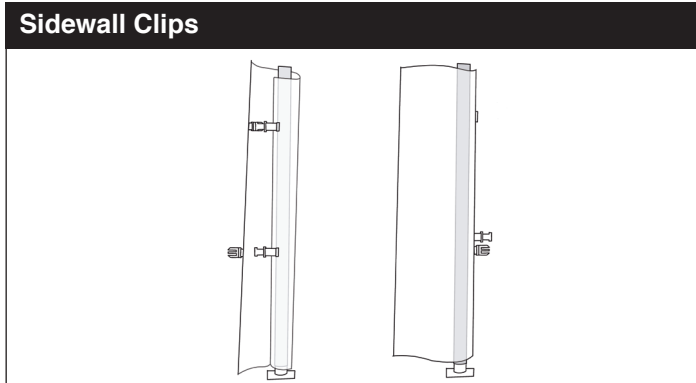
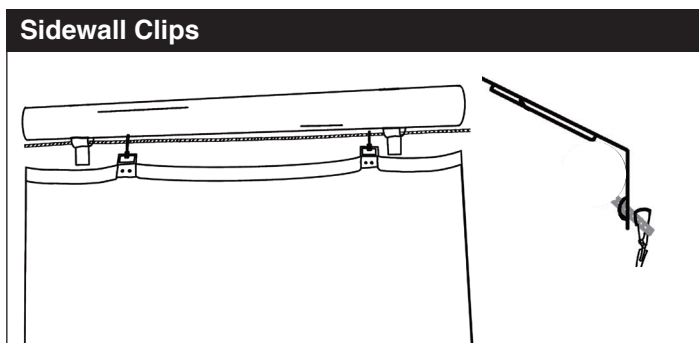

5. Use clips to either secure around the pole or attach to next sidewall section
6. Fan folding is best for storing your sidewalls; be sure they are clean and dry before fan folding them and storing them for the next time



# STRIKING

1. **Be careful! Poles, tent tops, and crew can be damaged if you don't use caution**
2. **Spread your drop cloth**
3. **Remove any additional accessories**
4. **Release some tension on ratchets, anything attached the center pole, so corners and poles inline with center, just a little**
5. **Detach all jumper ropes**
6. **Remove center poles and then side poles**
7. **Remove ratchets**
8. **Unlace tent top if sectional**
9. **Make sure tent top is clean and dry before folding and storing**

# CARE AND MAINTENANCE

## 1. How to Store a Tent

The first thing you need to know about storing your tent is summed up in two words: DROP CLOTH. You need a drop cloth. You may not think you need a drop cloth ("The ground is dry!" "It's just grass!" "This parking lot is clean!"), but trust us, you do. Drop cloths are the literal foundations of good tent husbandry. Why do you need a drop cloth for your tent? Drop cloths reduce the likelihood of:

- Pinholes--you know as well as we do that tiny pinholes make huge problems
- Tears--the easiest way to kiss your investment goodbye
- Dirt and grass stains
- Mystery residue from a surface you thought was safe

## 2. Bag It

If your tent was supplied with a bag, put your tent top back into the bag. This will keep it protected from hazardous situations. To return your tent to the bag, be sure to fold it the long way as many times as you can, then roll it up like a sleeping bag.

When you are storing your tent for the long term, beware of extreme temperatures. Too hot and your tent can be damaged, too cold and your tent could crack. Extreme cold is especially dangerous for our clear vinyl. Freezing cold temperatures can cause it to crack.

Clean with gentle cleaners like dish soap or powder laundry detergent. Avoid bleach, abrasive chemicals, and hard brushes.

## Storing Sidewalls

While you should still use your drop cloth when setting up and taking down sidewalls, it isn't as critical. Even so, handle with care. Rolling your sidewalls is the best way to store them and prevent damage.

## 3. How to Store Tent Poles

We've seen some inspirational systems for tent pole storage--beautiful structures designed exclusively to cradle poles while they wait for their next assignment. All you really have to do is make sure you handle them with care. Stack them on top of each other, but be sure to not clang or scrape them together. Use common sense and treat those poles with respect.

### Jack Jaw



## Tell us how it's going!

We would love to hear from you.

Please give us a review on our website, Facebook page, or Google. If you have any questions at all, please do not hesitate to contact our sales team at 920.888.4053.



### Address

2350 East Mason Street Suite 8  
Green Bay, WI, 54302



### Mail

sales@americantent.com



### Contact

920.888.4053



### Website

www.americantent.com



# TERMS & CONDITIONS

## TERMS AND CONDITIONS OF SALE

1. **Terms Control/Rejection of Conflicting Terms.** All sales are governed by these terms, and by placing an order, submitting payment, or providing Seller with a Purchase Order, Buyer agrees to these terms. Seller's offer to sell Buyer the Goods is conditioned on this acceptance. All other terms are rejected, including any terms included on any Purchase Orders from Buyer to Seller.
2. **Payment Terms.** Unless otherwise agreed in writing by Seller and Buyer, all order shall be prepaid in full before Seller ships any product subject to these Terms and Conditions (the "Goods"). If Buyer pays by check other than a cashier's check, Seller may delay shipment for a reasonable period as determined in Seller's sole discretion.
3. **Taxes.** Prices do not include sales, use, VAT, excise and other taxes or governmental charges with respect to the production, sale, distribution or delivery of the Goods. The final invoice amount includes all applicable taxes or governmental charges. Seller is responsible for proper remittance of all such taxes or governmental charges.
4. **Shipping.** Unless otherwise agreed in writing by Seller and buyer, shipment terms are F.O.B. Origin, Freight Prepaid and Add. Choice of carrier shall be in Seller's sole discretion.
5. **Returns/Cancellations.** All sales are final upon pickup or shipment from Seller's facility. Seller will not accept returns of any of the Goods except under certain circumstances as set forth in an authorized Returned Merchandise Authorization (RMA), which must include pictures of the tent purchased. RMA forms are available upon request. Seller holds sole discretion of authorization. Orders for Goods may be cancelled at any time prior to pick up or shipment from Seller's facility; provided, however, that any such cancellation shall result in a restocking fee of twenty-five percent (25%) of the original purchase price of the cancelled Order for having reserved a spot on our production schedule. This applies even for those orders that are via PO.
6. **Returns.** All sales are final. Seller will not accept returns of any of the Goods except under certain circumstances as set forth by an authorized RMA, which must include pictures of the tent erected. RMA forms are available upon request. Seller holds sole discretion of authorization.
7. **Force Majeure.** Seller will not be liable for any delay of its performance hereunder if the delay is directly or indirectly caused by or arises from fires, floods, terrorism, accidents, riots, war, government interference, embargoes, strikes, shortage of labor, materials or supplies, inadequate transportation facilities or any other cause beyond Seller's control.
8. **Warranty.** All tents are sold as is, and no warranties are given.
9. **Damages.** Any damages that occur as a result of improperly ballasted or improperly staked tents are the sole responsibility of the Buyer. Buyer acknowledges that tent must be ballasted or staked per the recommendations made by Seller. Seller will not be responsible for material, personal, or financial loss.
10. **Commitment to Cure.** We are committed to our workmanship and our customers. We will make right any issues with the tent top and/or parts prior to their initial use. Customers must bring any and all issues to our attention within 14 days of receipt of goods. We cannot honor requests for cure after 14 days of receipt.
11. **Limitation of Damages.** Seller shall not be liable for indirect, incidental, consequential, exemplary or punitive damages resulting from or arising in connection with any act or omission of Seller relating to any breach of these Terms and Conditions or relating in any way to the design, manufacture, delivery or use of the Goods. Seller's liability, regardless of grounds, shall be limited to the amount paid by Buyer for the Goods.
12. **Limitation of Actions.** Any statute of limitations notwithstanding, no claim shall be filed or brought against Seller for any breach of these terms and conditions after two (2) years of the date Buyer receives the Goods.
13. **Installation and Service.** Seller shall not be required to install, service or provide any on-site preparation or installation of any of the Goods. If Seller provides instruction to Buyer generally or specifically regarding any methods of installation, such instruction is gratuitous and is not to be considered a part of these Terms and Conditions.
14. **Nature of Goods as Temporary Structures.** Each of the Goods constitutes a temporary structure or part of a temporary structure that is not intended to meet any building or other codes. Buyer uses the Goods at his/her/ its sole risk.
15. **Modifications.** These Terms and Conditions may not be amended, modified, terminated or repudiated, in whole or in part, except in writing signed by Seller and Buyer.
16. **Remedies Not Exclusive.** No remedy of Seller provided herein is exclusive of any other remedy available to Seller.
17. **Assignment.** Buyer cannot assign any rights, duties or obligations hereunder without Seller's prior written consent.
18. **Governing Law and Venue.** These Terms and Conditions shall be governed by, and construed in accordance with, the laws of the State of Wisconsin, and any legal proceeding with regard to these Terms and Conditions or the Goods shall be brought in the Circuit Court for Brown County, Wisconsin. Buyer hereby waives any claims of forum non conveniens or any other similar claims.
19. **Cost of Collection.** Buyer shall be liable to pay Seller for all costs associated with any breach of these Terms and Conditions by Buyer, including Seller's actual attorney's fees.
20. **Authority of Signers.** Each person accepting these Terms and Conditions represents and warrants that he/she has been duly authorized to do so.
21. **Counterparts & Facsimile Signatures.** These Terms and Conditions may be signed in counterparts. Facsimile and electronic signatures shall have the same effect as originals. Placing and paying for an order online also acknowledges and agrees to these Terms & Conditions.
22. **Pickup Orders:** Customers may request to pick up purchased products from American Tent's facility in Green Bay, Wisconsin. Upon such request, the customer must schedule a pick-up time during American Tent's regular warehouse hours, which are 7:00 a.m. to 4:00 p.m., Monday through Thursday. Loading time will vary based on order size and method of transportation. Orders that are not picked up within five (5) business days of the scheduled pick-up date (Fridays excluded) may be subject to storage fees. Customers must mark any product shortages, damages, or other issues with the order prior to departure from American Tent's facility. The customer's signature on an American Tent acknowledgement receipt confirms that all proper products and quantities have been received and that such products are free of visible damage. Unless otherwise agreed in writing, the Customer is responsible for all product loading and providing or retaining transportation for all products placed for pick-up.