

# 30'x60' Frame Tent Safety & Set Up Guide



2350 East Mason St, Suite 8, Green Bay, WI 54302 | 920.431.0938 | sales@americantent.com | www.americantent.com

Thank you for your purchase from American Tent. The following procedures will help you through your installation. If you ever run into problems with the installation of your American Tent, give one of our sales/service professionals a call at 920.888.4053. Other product specific information, contact information, diagrams, and installation guides are available on our web site: [www.americantent.com](http://www.americantent.com).

## INDEX

Page 1.....	Tent & Equipment
Page 2.....	Safety
Page 3-5.....	Diagrams & Parts
Page 6.....	Tools
Page 7-9.....	Set Up
Page 10-13.....	Additional Assembly
Page 14.....	Sidewall Care
Page 15.....	Takedown & Storage
Page 16.....	Terms & Conditions

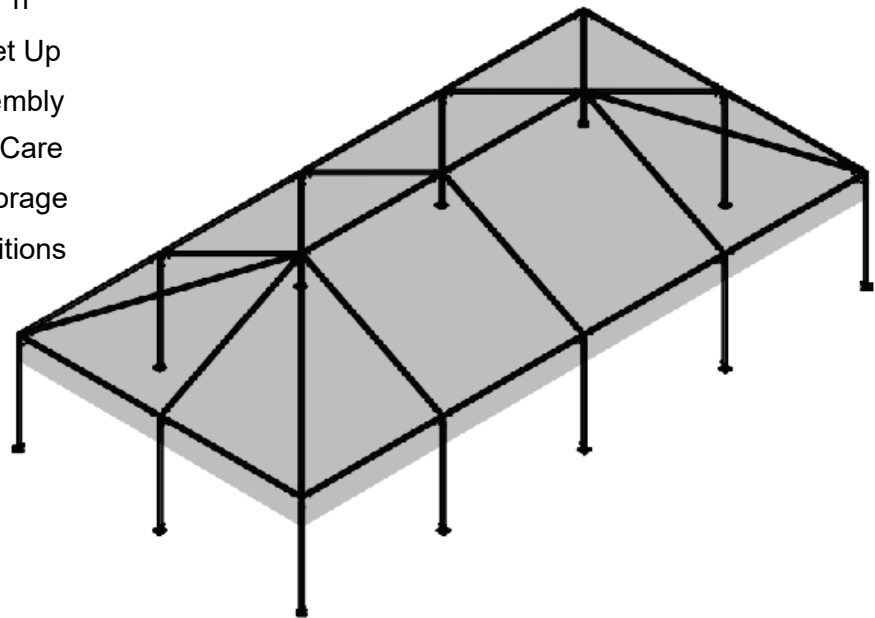

## REQUIRED EQUIPMENT

Sledge Hammer



Drop Cloth



4-6 People



# Weather

Weather is very unpredictable; the installer or end user must use their judgment, common sense and knowledge of conditions. The installer is responsible for anticipating weather severity for proper time and method of installation. *If inclement weather is predicted with winds that exceed 36 mph with gusts of more than 6 seconds the tent needs to be evacuated and guests directed indoors. This type of weather can lead to the tent becoming structurally unsafe. Please remember, this is a temporary, non-engineered structure.*

## The end user should be mindful of the following conditions:

### Wind

Wind can cause the tension of the tent to change by loosening ratchet assemblies, pulling stakes, or causing poles to shift or sink. It is important to do routine maintenance checks and maintain proper tension on the tent top at all times.

Additionally, to prevent damage such as rips or tears, consider disassembling your tent or safely removing your tent top if wind speeds reach 25 mph for more than 6 seconds. Persistent winds at this speed can stress the fabric, potentially leading to damage. We recommend taking the tent down under such conditions to keep your tent in pristine condition, use after use.

### Rain

Water can collect on the tent fabric causing 'ponding' under certain conditions, especially if the tent is not installed & tensioned correctly. Ponding can destroy the tent fabric & cause poles to sink into the soil. Additionally, saturated soil can cause stakes to lose their holding power.

### Lightning

It is very dangerous to be under a tent during a lighting storm. Immediately leave the tent until the chance of lightning is no longer present.

### Snow

Tents are not designed to carry any type of snow loading. This product should not be used if snow has been allowed to accumulate.

---

## Site Selection

**CRITICAL:** Before staking, contact your local utility 811 number and have the site checked.

*Scan the QR code to find your local number.*



### Look carefully at the factors below when selecting a site:

- Soil Conditions**– Adequate for anchoring
- Location**– Elevated, level, and clear of debris
- Space**– Check perimeter for space to anchor the tent
- Surface**– Grass, Gravel, Concrete, Asphalt, Wood
- Site Access**– Services and delivery can easily be achieved
- Check Overhead**– Look for any electrical lines or tree branches
- Underground Utilities**– Utilities must be located.

*Use the 811 service to schedule a utility locate. If staking, be aware of underground electric, gas, oil, steam, telephone, CATV, water, sewer services. Have the site checked prior to staking.*

**Weather**– Monitor for weather conditions and evacuate if necessary

**Emergency Exits**– Easily accessible exit routes in case of emergency

## Fire Safety



Our tents come with a tag confirming this product is manufactured using flame-resistant fabric that **meets or exceeds NFPA-701-2**

### Safety Checklist:

- When building or assembling anything above shoulder height, wear a hard hat
- Steel toe boots are recommended
- Inspect the site– look for overhead and underground obstructions
- Call your local utility to have the area marked ahead of time
- Inspect all ropes and tie lines and replace/repair as needed
- Inspect all poles and fittings to make sure there are no bends or breaks
- Replace or repair any items in poor condition
- CALL 8-1-1 BEFORE DOING ANY STAKING**

The installer must follow local building codes and fire regulations, and evaluate the site for proper securing and anchoring for the conditions.





# 30x60 Frame Tent

## Roof Package: Fittings & Hardware





2350 East Mason Street, Suite 8, Green Bay, WI 54302 | 920.431.0938 | sales@americantent.com | www.americantent.com

### FITTINGS

- 
**4x** **CRN** Corner  
PUR-FIT-CRN
- 
**2x** **6CR** 6-Way Crown  
PUR-FIT-6CR
- 
**1x** **RCR** Ridge Crown  
PUR-FIT-RCR
- 
**8x** **4ST** Side Tee w/Ring  
PUR-FIT-4ST
- 
**12x** **BPL** Baseplate  
PUR-FIT-BPL

Look carefully: Ridge Crown and Side Tee with Ring are similar, but not interchangeable; if it has a ring, it's a Side Tee with Ring

### HARDWARE

- 
**68x** **△** Bail-Pin  
PUR-PIN-BPN
- 
**12x** **Ⓡ** R-Pin  
PUR-PIN-RPN

Prevent damage to vinyl by ensuring that the open end of pin is positioned away from tent top

- 
**3x** **—** 30' Cable  
PRT-CBL-30F

Install cables before the legs and tent top

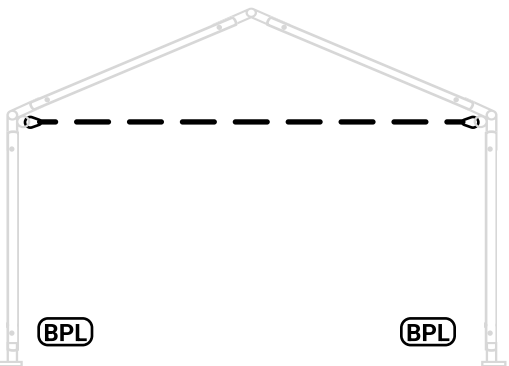

Baseplates insert at the foot of every leg

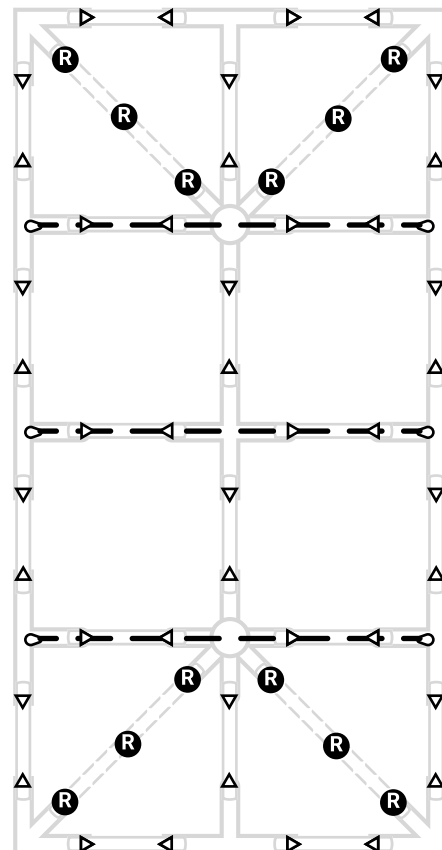
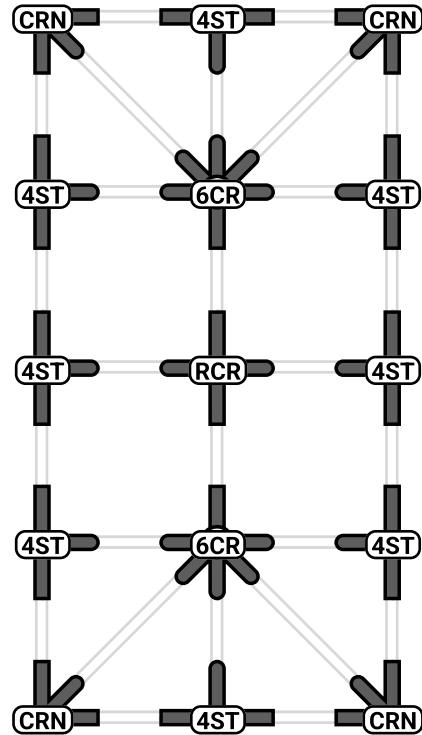













# 30x60 Frame Tent

## Roof Package: Poles & Legs



2350 East Mason Street, Suite 8, Green Bay, WI 54302 | 920.431.0938 | sales@americantent.com | www.americantent.com

### POLES

- 
**12x A**  6'8" (80") or 7'8" (92")  
 PRT-POL-SGL-6F8N OR 7F8N
  - 
**14x B**  14'4" (172")  
 PRT-POL-SGL-14F4N
  - 
**8x C**  16'1" (193")  
 PRT-POL-SGL-16F4N
  - 
**4x D1**  10' 10.25" (130.25")  
 PRT-POL-DBL-10F10.25N
  - 
**4x D2**  10' 10.25" (130.25")  
 PRT-POL-DBL-10F10.25N
- Note: Poles D1 and D2 connect together to make Pole D. See Double Tube Set Up Instructions for further detail.
- 
**4x D**  21'8.5" (260.5")  
 PRT-POL-DBL-21F10.5N

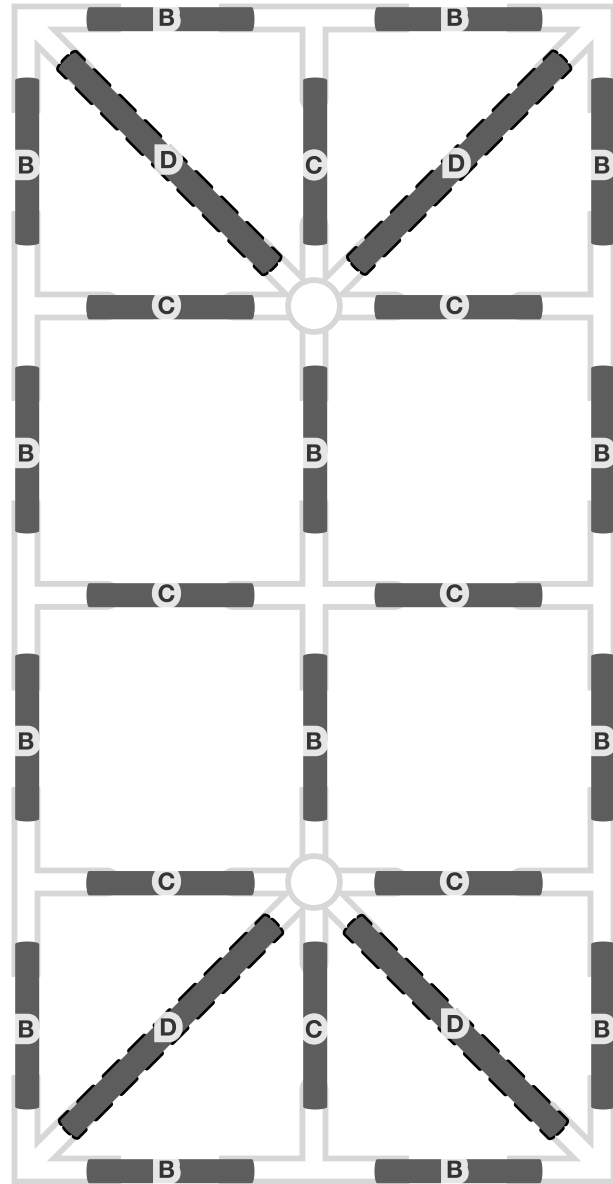

# 30x60 Frame Tent Anchoring Packages



2350 East Mason Street, Suite 8, Green Bay, WI 54302 | 920.431.0938 | sales@americantent.com | www.americantent.com

## STAKE & BOLT ANCHORING

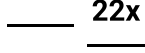
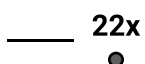
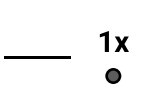
- 
**22x** Ratchet Strap  
KIT-RAT-2N
- 
**22x** Eye Bolt & Concrete Anchor  
AMT-KIT-FRT-CON
- 
**1x** Eye Bolt Set Tool  
AMT-KIT-FRT-CON
- OR---

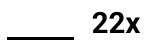
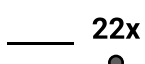
**22x** Ratchet Strap  
KIT-RAT-2N
- 
**22x** Stake  
PUR-STK-STD

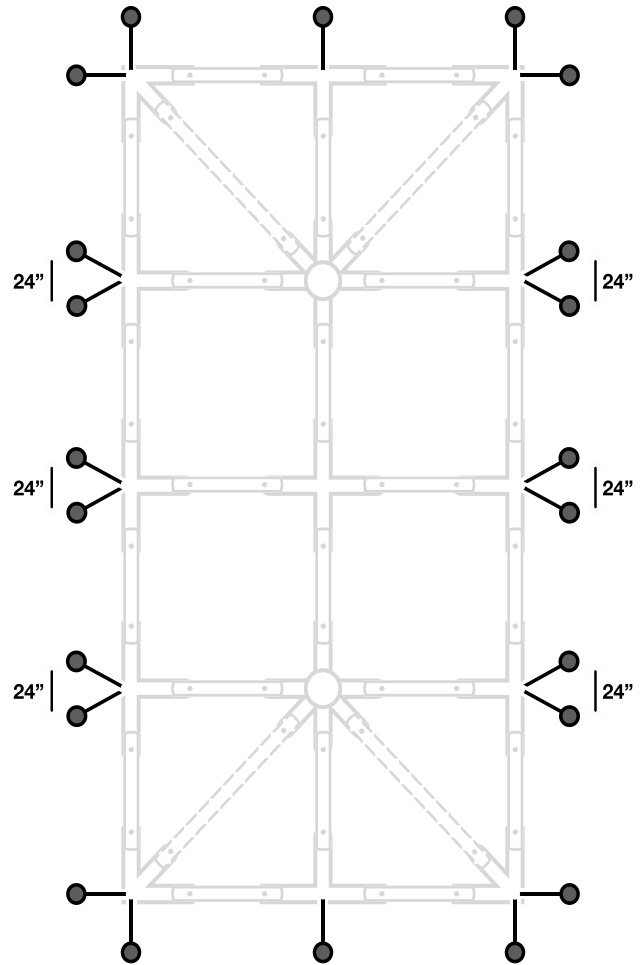
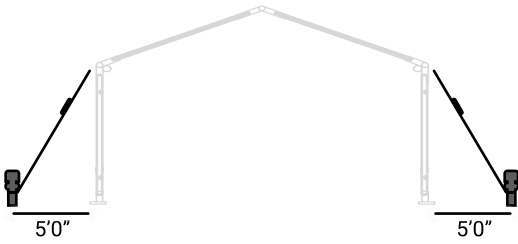

# STAKE AND BOLT ANCHORING

The installer must follow local building and fire codes, and evaluate the site for proper staking and anchoring

*Before staking please contact your local utility 811 service and have the site checked. Use this link to find the phone number for your state: <https://call811.com/811-In-Your-State> or dial 811 on your phone.*

If you are using stakes to secure your tent:

## Step 1

Lay out the area where you will be constructing the tent by marking corners and stake locations with spray paint. The illustration on this page shows the measurements you should use for this tent. Notice that the stake line is 10 feet larger than the tent outline to accommodate a 5 foot spacing outside the tent for stakes. Use the diagonal measurement to confirm the corners are square.

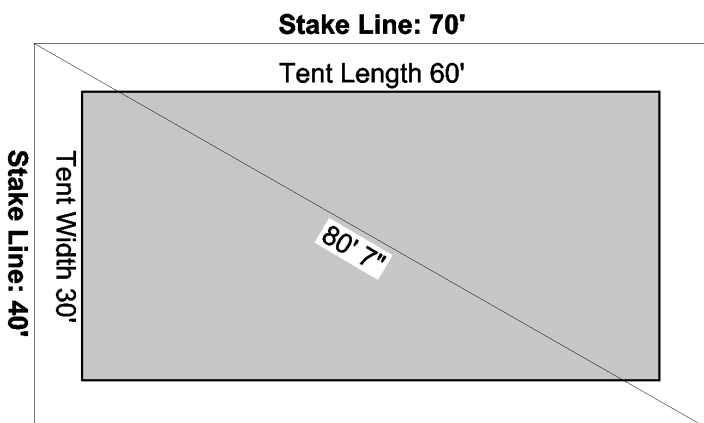

## Step 2

Drive a stake approximately 5' away for 7' legs, 6' away for 8' legs, and so on. Stakes should have 6" or less of the head exposed. The deeper the stake is driven, the better the holding strength. Stakes driven vertically also have better holding strength than stakes driven at an angle.

The ratchet straps will be attached once the frame is erected.

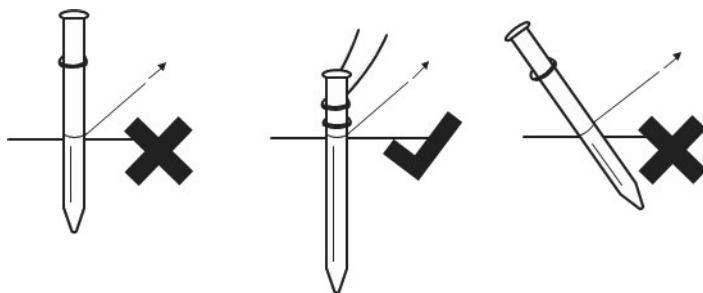

## Ratchets Overview



## Concrete Anchor Kit

1. Using a Hammer Drill with a 3/4" masonry drill bit, drill a hole in the same location you would normally put a stake. The anchor should be placed at a minimum depth of 1-1/4"
2. Remove all dust and debris from the hole with a vacuum or compressed air.
3. Place the anchor into the hole and set the anchor with an Anchor Setting Tool and a hammer.
4. When the anchor is set to the correct depth, thread the eye bolt in.
5. Pull looped end of the strap through the eye bolt. Take the other end of the strap and pull it all the way through the loop. Pull long end tight to secure the strap to eye bolt.

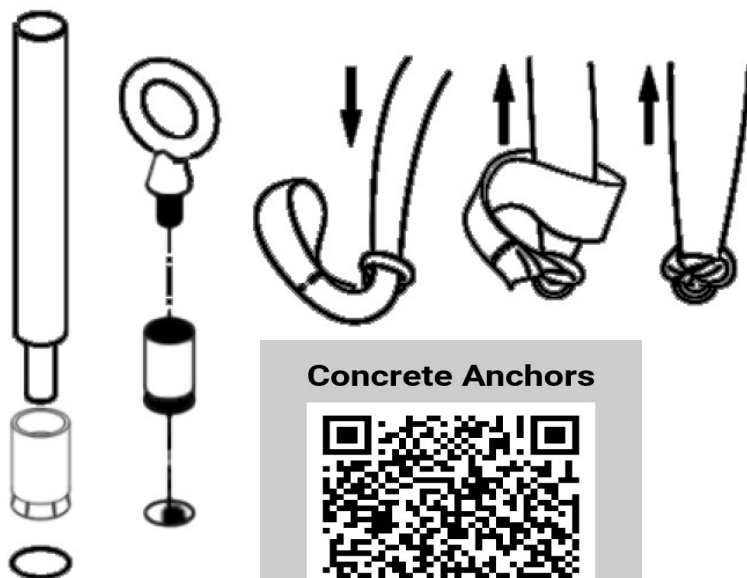

## Concrete Anchors



# SET UP

Please know that your safety is our priority. Before setting up your tent, be sure to confirm with your local utility locating service that it is safe to set up your tent in your desired location. Be aware of potential weather conditions, and always evacuate your tent during periods of extraordinarily high winds or lightning.

## 1. Place the frame parts on the ground.

Put them in their approximate locations where they will be when the frame is assembled. This ensures all parts are accounted for at the beginning of your tent set up. See diagrams on pages 3-5.

## 2. Place pins in 6-way crowns.

- Each protrusion on the crown has two holes. One hole is closer to the center (alignment hole), and the other is further down the protrusion (placement hole).
- Place a pin in the alignment hole. The pin prevents the rafter from moving too far onto the crown.

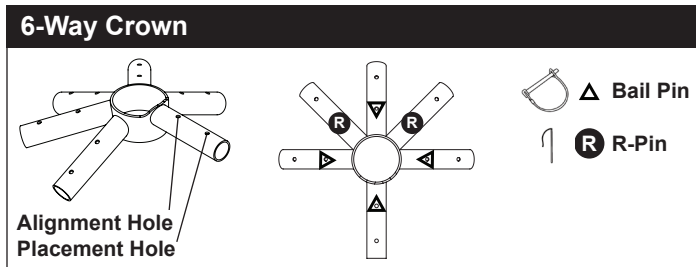

## 3. Connect 6-way crown to Pole D.

- Slide tubing onto the protrusion until it meets the pin.
- Align placement hole in the crown with hole in the pole and insert pin
- Remove alignment hole pin

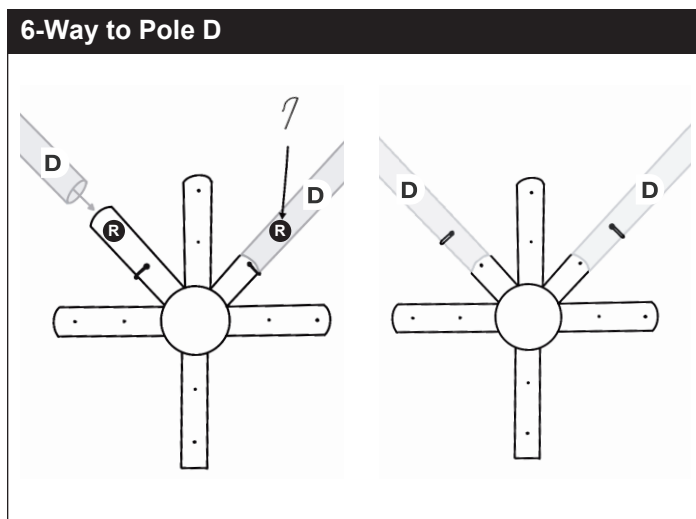

## 4. Connect the rest of the tubing to the 6-way crown.

### ⚠ Pro tip

While building your tent attach R-Pins in similar directions. When you lift the tent top over the frame later on, this will minimize the risk of tearing and pulling.

## 5. Build your frame top in sections.

Build 6-way crown sections, as shown according to your diagram. Connect mids one at a time, working across the length of the tent connecting all poles and fittings. Finish at second end bay.

### End Bay Construction

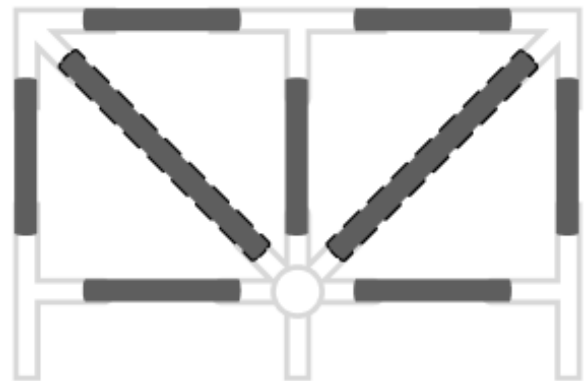

**Please note:** If an attachment is not marked with a R pin, use a bail pin

### Frame Sections

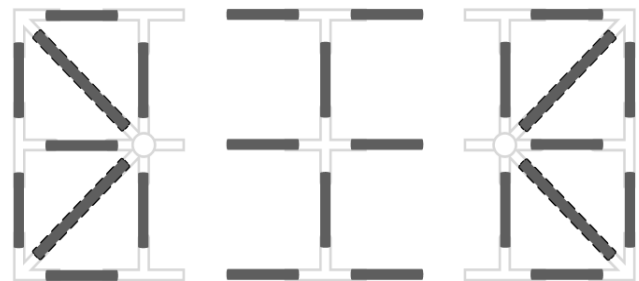

- 6. Attach one carabiner on 30' cable to O ring on side tee. Pull cable across 30' width. Connect other end of cable to side tee on adjacent side by Attaching other carabiner to O ring on fitting.**  
Repeat at all side tees.  
Reference diagram for placement.

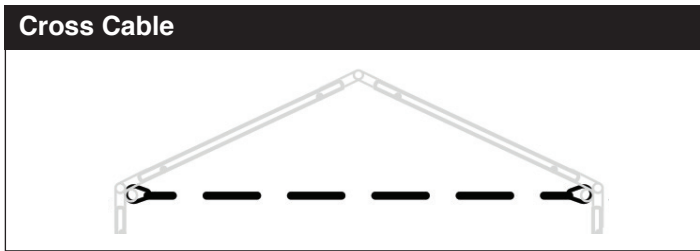

- 7. You should now have an assembled frame top that looks like your tent's diagram.**
- 8. Loop end of each ratchet strap to fitting at each leg location.**

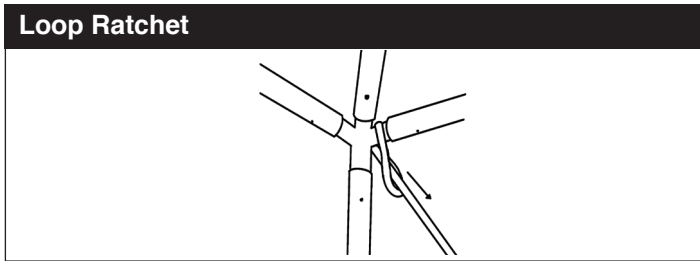

- 9. Unroll the tent top**  
Place pieces on a drop cloth to protect the tent from dirt and abrasions. Align lace side of piece to grommet side of next piece.

- 10. Lace tent together.**
- Line up each section (lace at bottom) so they overlap
  - Pull first lace up through first small grommet. Pull second lace up through second grommet and then pull through the loop of the first lace and so on.
  - Tie off at end to secure whole lace line
  - Repeat to secure all other lace lines
  - Fold the rain flap over connecting velcro-like material on either side of the laces

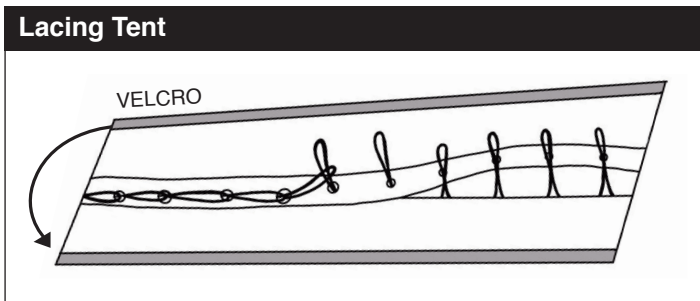

- 11. Install the Tent Top**

O-rings are intended for installation only and should not be used for anchoring or attaching ratchets.

- 12. Center tent top on frame by hiding the seams behind hip rafters. Loosely fasten the alligator straps at each side of the corners around the perimeter tubing and at each lace line to secure the tent top.**
- 13. Attach the base plates to legs securing with a pin.**
- 14. Lift the downwind side of the frame, keeping it level along the length of the tent to avoid bending the poles.**  
No matter what the wind conditions are, always lift the downwind side of the tent first. This prevents the wind from catching the tent. Do not lift one corner at a time. Instead, lift up the entire side.
- 15. Attach all leg poles to the lifted side.**

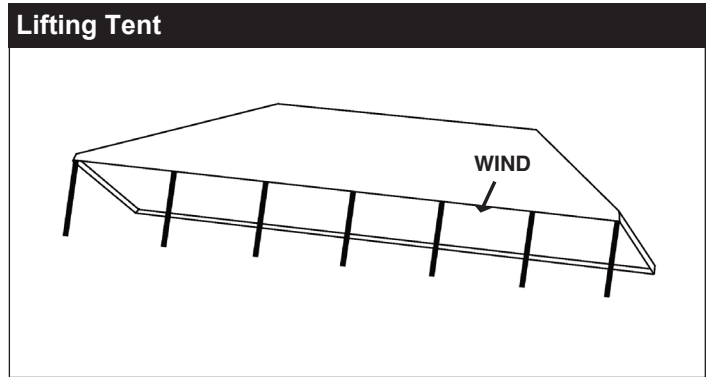

- 16. Place stakes 5' out from each leg; drive stakes into the ground so that ideally 6" or less of the stake shows.**

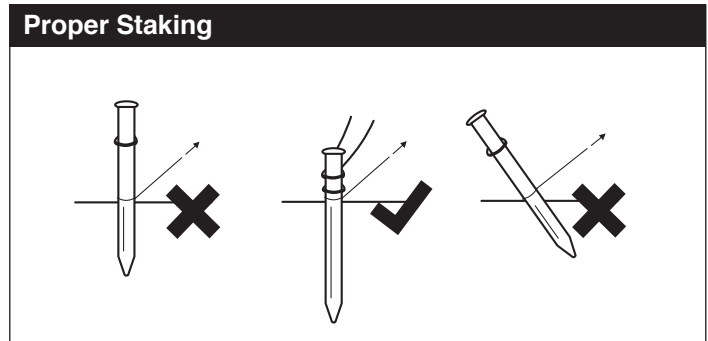

**17. Attach ratchet straps to the stakes loosely.**

Attach ratchet buckle with loop strap to stakes by turning the 6" loop at the end of the ratchet inside out and pull strap through the loop. This will create a slipknot to pull tight over the stake. Take loop strap attached to tent and pull it through reel bars slot of ratchet. Keep ratchet buckle handle facing up at all times. Pull other loop strap back towards tent approximately 18 inches.

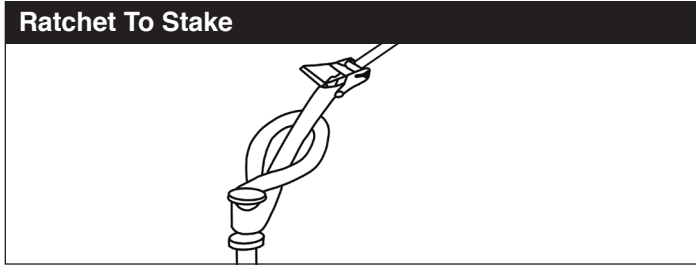

**18. Fasten the rest of the alligator straps around perimeter tubing. Do this by tugging on the valence to keep the material taut and firmly pulling the straps. Slide excess strap through the metal slide on the alligator clip.**

Pulling too hard will cause undue wear and tear as well as wrinkling in the tent top fabric.

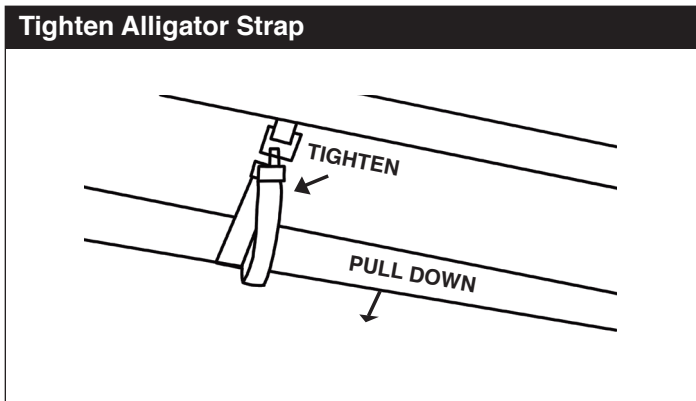

**19. Raise the other side of the tent and secure on remaining legs.**

**20. Tighten ratchet straps by holding strap with one hand and cranking ratchet handle with the other.**

**Roll Excess Strap**

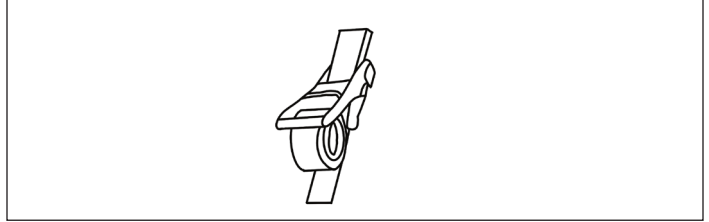

**21. Roll excess ratchet straps and secure into the ratchet buckle.**

**22. Congratulations! Your tent should now be complete.**

For further assembly of additional accessories and attachments please see pages 10-13

# ADDITIONAL PRODUCT ASSEMBLY

## SIDEWALLS

1. Terminate sidewall rope at one end with sidewall rope clamp, if included
2. Carefully unroll the sidewall so that it is a long, fan folded piece
3. Pick up the sidewall and carry on one shoulder while clipping every third clip with the opposite arm
4. Make sure the open side of the clips are facing in towards you

### Sidewall Clips

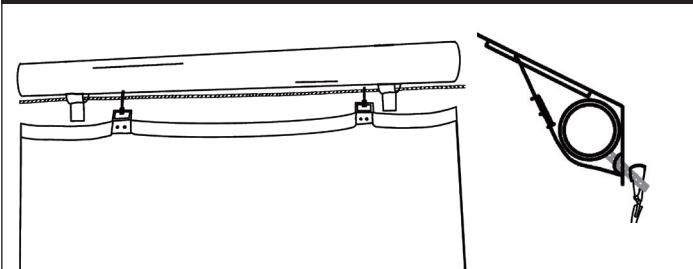

5. Once every third clip has been attached, go back and clip the rest

6. Use clips to either secure around the pole or attach to next sidewall section

### Sidewall Clips

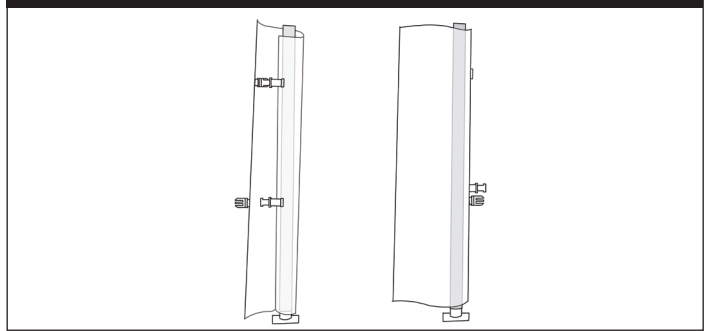

7. Fanfolding is best for storing your sidewalls; be sure they are clean and dry before fan folding them and storing them for next time

### Need Help?

Check out our Youtube channel for instructional videos and how-tos!  
Or give us a call at 920-431-0938



## RAIN GUTTER

1. Take two tents and move them rightly 8" apart from each other

### Leg Spacing

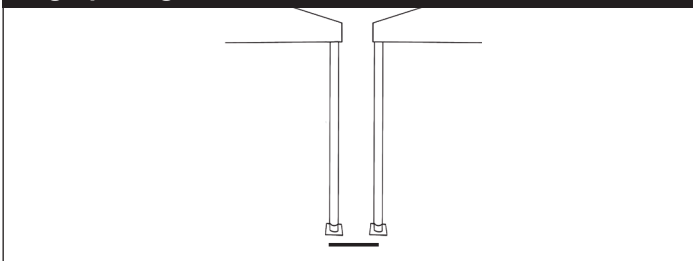

2. Similar to a sidewall, the rain gutter will attach to the sidewall rope.
3. Take the clips of one side and attaching them to the rope located on the underside of the first tent.

4. After attaching the first side, take the second side and repeat on the underside of the second tent

### Rain Gutter

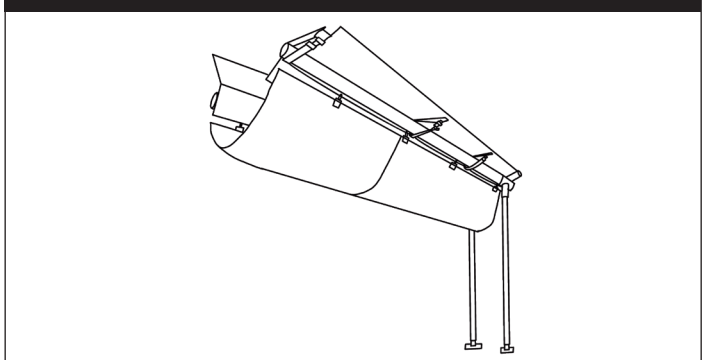

# Frame Tent 9 & 10' Leg Bracing Package



2350 East Mason Street, Suite 8, Green Bay, WI 54302 | 920.431.0938 | sales@americantent.com | www.americantent.com

Identify the side leg and corner leg Brackets, and lay them out where they should be installed at each leg. The difference is that at the point where they connect. The corner bracket will be at a 90 degree angle and the side bracket will be straight.

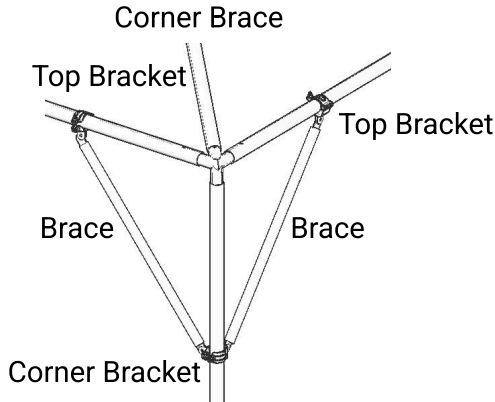

In both side and corner configurations, braces should be at a 45 degree angle to the leg. The bolt portion of the clamp should face the inside of the tent.

**Warning:** Slide brackets onto eaves and legs before attaching fittings.

To install:

1. Slide brackets onto eave and leg tubes during tent assembly with bolt to inside of tent. The bolt should be loose enough to slide for easy adjustment.
2. Next, attach brace to side leg bracket with a bolt and nut. Swing brace up, and attach to top bracket with a bolt and nut. Repeat for second brace.
3. After the second brace is in place, adjust the entire assembly so that the two braces are at 45 degree angles to the leg tube. Tighten bracket and brace bolts with a wrench so they are securely attached to the frame. See diagrams on the left.
4. Install the corner braces in the same manner.

Side Brace

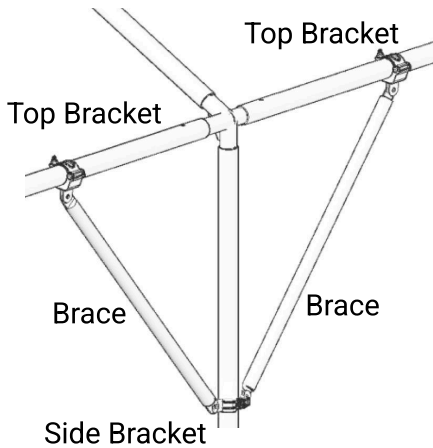

## 9 & 10' Extender Base Plates

To install:

1. Insert a base extender in each leg, then insert a pin in the proper hole for the height that is desired. See the illustrations below.

9 foot leg extension. Three holes should be showing, with the pin in the 4th hole.

10 foot leg extension. Six holes should be showing, with the pin in the 7th hole.

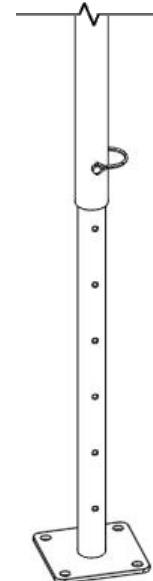
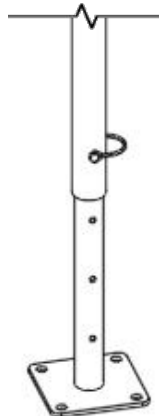

Identify the Guards, and lay them out where they should be installed.

## Single Tube PinGuard



Installation:

1. Open and attach the wide end of PinGuard to the pole.
2. Attach narrow end of Guard to fitting ensuring bail is seated in Guard.



## Double Tube PinGuard



Installation:

1. Open and attach PinGuard to the double tube ensuring R-pin is seated in the Guard.

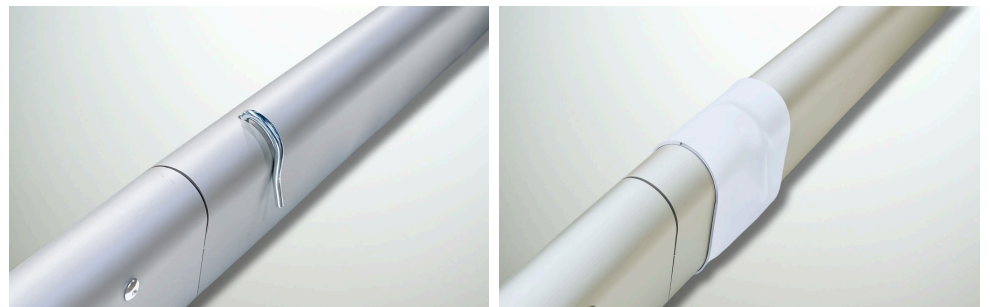

# DOUBLE TUBE ASSEMBLY

The following illustrations show how to set up one full 21' 8.5" double tube

1X RIVET SIDE

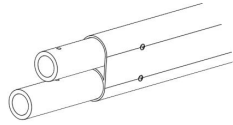

1X R-PIN SIDE

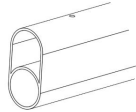

1X R-PIN



1. Ensure that the double tube is lined up properly with the R-pin hole facing up. The circle portion of the double tube should match with the longer insert.

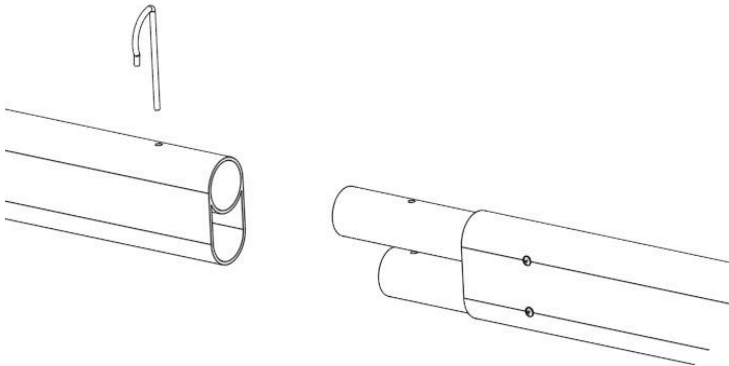

FRONT VIEW



Note: The longer insert should go into the circle side of the double tube

TOP VIEW

2. Slide the rivet side of the double tube into the R-Pin side.

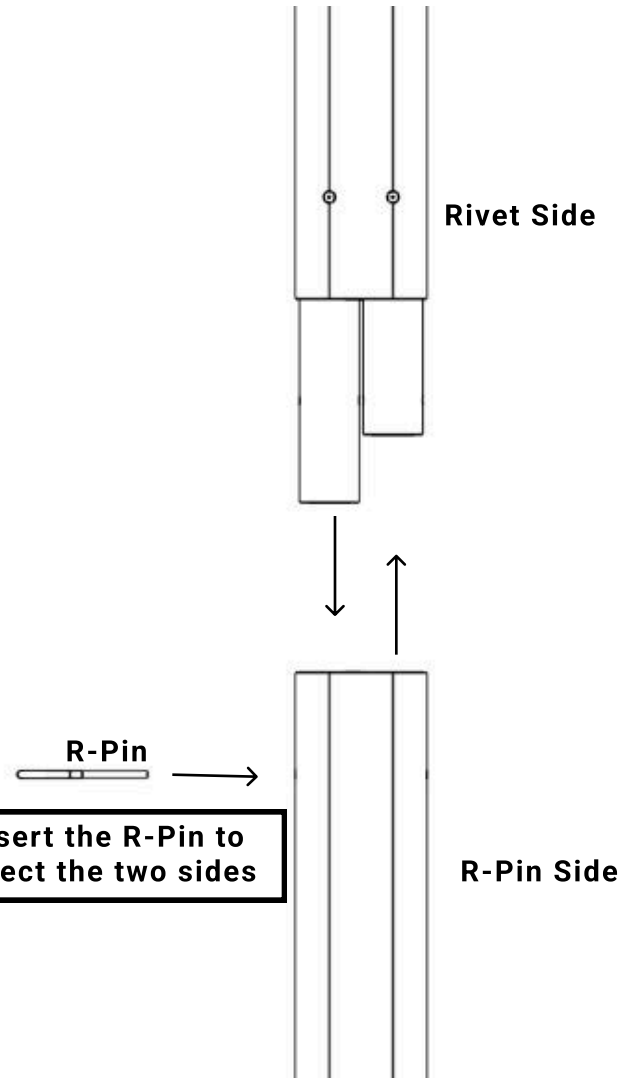

3. Insert the R-Pin to connect the two sides

FINAL ASSEMBLY

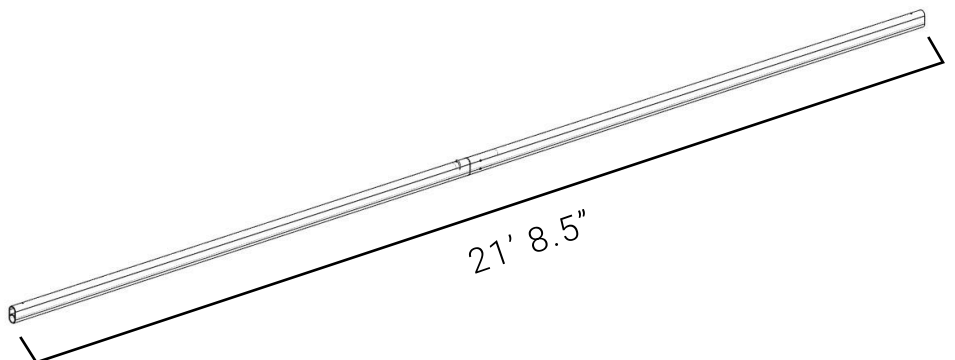

# Sidewall Care

## Understanding Your Tent Sidewalls

Sidewalls are an important part of your tent system, providing protection from weather and helping create an enclosed space. Because of how they function, they naturally experience more movement and stress than the tent top.

While tent tops are designed to remain tightly tensioned and shed wind, sidewalls are vertical panels that can catch wind and flex during use. This is normal and expected behavior.

## What to Expect Over Time

Sidewalls are designed for durability and repeated use, but they will show wear over time - especially in environments with consistent wind or extended setup periods. This is similar to other outdoor materials that are exposed to movement and the elements.

## Why Wear Can Occur

Several factors can contribute to wear on sidewalls:

- **Wind Movement:** Sidewalls can shift and flex in the wind, which may cause stress on the material over time
- **Contact Points:** Movement may lead to occasional contact with tent poles or surrounding surfaces
- **Ground & Debris:** Rocks, gravel, or uneven surfaces can contribute to abrasion
- **Temperature Conditions:** In colder temperatures, materials can become less flexible and more prone to damage

## Best Practices to Extend Lifespan

To get the most life out of your sidewalls, we recommend:

- Removing sidewalls when the tent is not in use, especially during extended setups
- Avoiding direct contact with rough or abrasive surfaces
- Taking extra care when installing or removing sidewalls in colder temperatures

## We're Here to Help

If you ever have questions about your setup or want tips for improving performance in your specific environment, our team is always happy to help.

# Striking and Storage

## Taking Down Your Tent

1. Loosen ratchet strap assemblies.
2. Remove side and end legs.
3. Unfasten all alligator straps except the two at each corner and the ones at the lace line.
4. Remove the legs from one side and carefully set the tent frame on the ground.
5. Repeat with the opposite side.
6. Unfasten the rest of the alligator straps until all are completely disconnected.
7. Roll out your drop cloth on the side you will be removing the top from.
8. Remove the tent top from the frame, landing it on the drop cloth.
9. If your tent has laces, unlace your tent top. Untie the knot and unlace the tent top section while opening the rain flap.
10. Fan fold and tightly roll the tent top pieces. For the longevity of your tent, take down, disassemble, roll and bag your tent only when completely dry and free from leaves or any other foreign matter.
11. Place your rolled tent top into its bag.
12. Fold and roll up the drop cloth.
13. Disassemble all of the corner & side tee fittings by removing the pins, and sliding the tubing off of the fittings. Work from the perimeter of the frame inward, finishing at the crown.
14. Remove all stakes. A tool that makes this easier is a Jack Jaw Stake Extractor available from American Tent.

### Jack Jaw



## Storing Your Tent

This process begins at the tent strike. You need a drop cloth to protect your tent top as well as to keep it clean and dry prior to storage.

Drop cloths reduce the likelihood of:

- Pinholes
- Dirt & grass stains
- Mystery residue

### Bag it

If your tent was supplied with a bag, put your tent back into the bag. This will keep it protected from the elements.

### Storing Sidewalls

Fan folding and flat stacking is the best way to store sidewall, again its very important to store all vinyl clean and dry in a cool dry environment .

### Cleaning

When washing your tent make sure the soap you use is safe for your tent fabric. Use a tent cleaner available from American Tent or gentle cleaners like dish soap or mild laundry detergent. Completely avoid Bleach, Abrasive Chemicals, any cleaner with Petroleum Distillates, and hard brushes. Once tents are completely dry they can be folded, rolled and bagged for next use.

### Caring For Your Tent:

The setup and take down process can make or break a tent--literally. Placing your tent tops directly on the ground is never a good idea. A tent on the ground is at extreme risk for pinholes, dirt, and other damage. Protect your tent from damage with a drop cloth.

Handle poles with care. Stack them on top of each other, but be sure to not drop or scrape them together.

When you are storing your tent for the long term, beware of extreme temperatures. Too hot and your tent can be damaged, too cold and your tent could crack. Extreme cold is especially dangerous for our clear vinyl. Freezing cold temperatures can cause it to crack. Store tents in a sheltered place where the temperature will stay above freezing.

# TERMS & CONDITIONS

## TERMS AND CONDITIONS OF SALE

1. **Terms Control/Rejection of Conflicting Terms.** All sales are governed by these terms, and by placing an order, submitting payment, or providing Seller with a Purchase Order, Buyer agrees to these terms. Seller's offer to sell Buyer the Goods is conditioned on this acceptance. All other terms are rejected, including any terms included on any Purchase Orders from Buyer to Seller.
2. **Payment Terms.** Unless otherwise agreed in writing by Seller and Buyer, all order shall be prepaid in full before Seller ships any product subject to these Terms and Conditions (the "Goods"). If Buyer pays by check other than a cashier's check, Seller may delay shipment for a reasonable period as determined in Seller's sole discretion.
3. **Taxes.** Prices do not include sales, use, VAT, excise and other taxes or governmental charges with respect to the production, sale, distribution or delivery of the Goods. The final invoice amount includes all applicable taxes or governmental charges. Seller is responsible for proper remittance of all such taxes or governmental charges.
4. **Shipping.** Unless otherwise agreed in writing by Seller and buyer, shipment terms are F.O.B. Origin, Freight Prepaid and Add. Choice of carrier shall be in Seller's sole discretion.
5. **Returns/Cancellations.** All sales are final upon pickup or shipment from Seller's facility. Seller will not accept returns of any of the Goods except under certain circumstances as set forth in an authorized Returned Merchandise Authorization (RMA), which must include pictures of the tent purchased. RMA forms are available upon request. Seller holds sole discretion of authorization. Orders for Goods may be cancelled at any time prior to pick up or shipment from Seller's facility; provided, however, that any such cancellation shall result in a restocking fee of twenty-five percent (25%) of the original purchase price of the cancelled Order for having reserved a spot on our production schedule. This applies even for those orders that are via PO.
6. **Returns.** All sales are final. Seller will not accept returns of any of the Goods except under certain circumstances as set forth by an authorized RMA, which must include pictures of the tent erected. RMA forms are available upon request. Seller holds sole discretion of authorization.
7. **Force Majeure.** Seller will not be liable for any delay of its performance hereunder if the delay is directly or indirectly caused by or arises from fires, floods, terrorism, accidents, riots, war, government interference, embargoes, strikes, shortage of labor, materials or supplies, inadequate transportation facilities or any other cause beyond Seller's control.
8. **Warranty.** All tents are sold as is, and no warranties are given.
9. **Damages.** Any damages that occur as a result of improperly ballasted or improperly staked tents are the sole responsibility of the Buyer. Buyer acknowledges that tent must be ballasted or staked per the recommendations made by Seller. Seller will not be responsible for material, personal, or financial loss.
10. **Commitment to Cure.** We are committed to our workmanship and our customers. We will make right any issues with the tent top and/or parts prior to their initial use. Customers must bring any and all issues to our attention within 14 days of receipt of goods. We cannot honor requests for cure after 14 days of receipt.
11. **Limitation of Damages.** Seller shall not be liable for indirect, incidental, consequential, exemplary or punitive damages resulting from or arising in connection with any act or omission of Seller relating to any breach of these Terms and Conditions or relating in any way to the design, manufacture, delivery or use of the Goods. Seller's liability, regardless of grounds, shall be limited to the amount paid by Buyer for the Goods.
12. **Limitation of Actions.** Any statute of limitations notwithstanding, no claim shall be filed or brought against Seller for any breach of these terms and conditions after two (2) years of the date Buyer receives the Goods.
13. **Installation and Service.** Seller shall not be required to install, service or provide any on-site preparation or installation of any of the Goods. If Seller provides instruction to Buyer generally or specifically regarding any methods of installation, such instruction is gratuitous and is not to be considered a part of these Terms and Conditions.
14. **Nature of Goods as Temporary Structures.** Each of the Goods constitutes a temporary structure or part of a temporary structure that is not intended to meet any building or other codes. Buyer uses the Goods at his/her/ its sole risk.
15. **Modifications.** These Terms and Conditions may not be amended, modified, terminated or repudiated, in whole or in part, except in writing signed by Seller and Buyer.
16. **Remedies Not Exclusive.** No remedy of Seller provided herein is exclusive of any other remedy available to Seller.
17. **Assignment.** Buyer cannot assign any rights, duties or obligations hereunder without Seller's prior written consent.
18. **Governing Law and Venue.** These Terms and Conditions shall be governed by, and construed in accordance with, the laws of the State of Wisconsin, and any legal proceeding with regard to these Terms and Conditions or the Goods shall be brought in the Circuit Court for Brown County, Wisconsin. Buyer hereby waives any claims of forum non conveniens or any other similar claims.
19. **Cost of Collection.** Buyer shall be liable to pay Seller for all costs associated with any breach of these Terms and Conditions by Buyer, including Seller's actual attorney's fees.
20. **Authority of Signers.** Each person accepting these Terms and Conditions represents and warrants that he/she has been duly authorized to do so.
21. **Counterparts & Facsimile Signatures.** These Terms and Conditions may be signed in counterparts. Facsimile and electronic signatures shall have the same effect as originals. Placing and paying for an order online also acknowledges and agrees to these Terms & Conditions.
22. **Pickup Orders:** Customers may request to pick up purchased products from American Tent's facility in Green Bay, Wisconsin. Upon such request, the customer must schedule a pick-up time during American Tent's regular warehouse hours, which are 7:00 a.m. to 4:00 p.m., Monday through Thursday. Loading time will vary based on order size and method of transportation. Orders that are not picked up within five (5) business days of the scheduled pick-up date (Fridays excluded) may be subject to storage fees. Customers must mark any product shortages, damages, or other issues with the order prior to departure from American Tent's facility. The customer's signature on an American Tent acknowledgement receipt confirms that all proper products and quantities have been received and that such products are free of visible damage. Unless otherwise agreed in writing, the Customer is responsible for all product loading and providing or retaining transportation for all products placed for pick-up.