

# 30' x 40' Frame Tent Safety & Set Up Guide



2350 East Mason St, Suite 8, Green Bay, WI 54302 | 920.431.0938 | sales@americantent.com | www.americantent.com

Thank you for your recent purchase from American Tent. The following procedures will help you through your installation. If you ever run into problems with the installation of your American Tent give one of our sales/service professionals a call at 920.431.0938. Other product specific information, contact information, diagrams, and installation guides are available on our web site at [www.americantent.com](http://www.americantent.com).

## INDEX

Page 1.....Tent & Equipment  
Page 2-4.....Diagrams & Parts  
Page 5-4..... Safety & Maintenance  
Page 7-9..... Set Up  
Page 10..... Striking  
Page 11.....Additional Assembly  
Page 14-18.....Ameritrac Keder Set Up  
Page 19.....Terms & Conditions

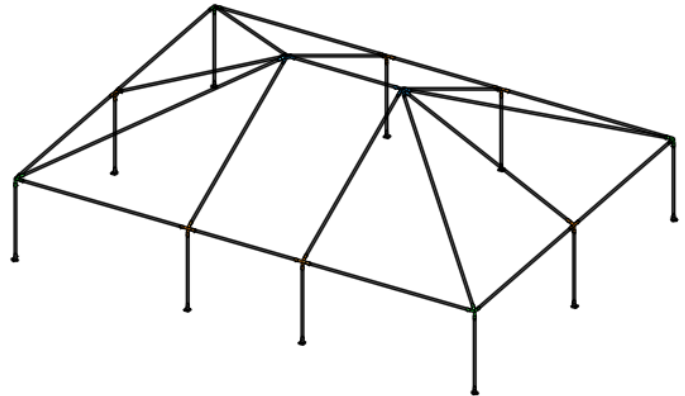

## REQUIRED EQUIPMENT

Sledgehammer



Drop Cloth



2-3 People



# 30x40 Frame Tent Roof & 7' Leg Package: Poles









2350 East Mason Street, Green Bay, WI

920.431.0938

sales@americantent.com



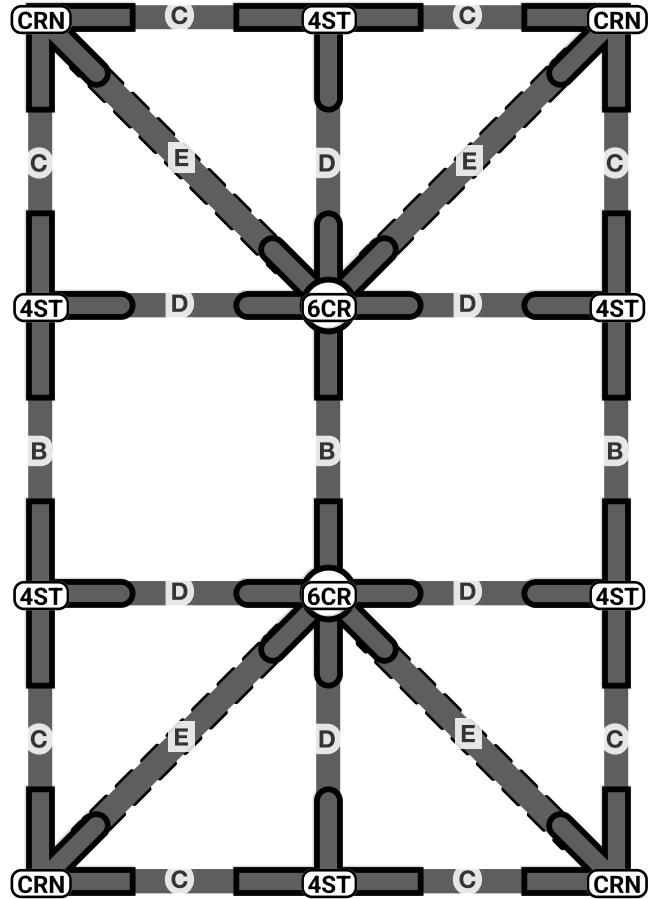

www.americantent.com

## POLES

- 10x**  
**A**  **6'8" (80")**  
 PRT-POL-SGL-6F8N
  - 3x**  
**B**  **9'4" (112")**  
 PRT-POL-SGL-9F4N
  - 8x**  
**C**  **14'4" (172")**  
 PRT-POL-SGL-14F4N
  - 6x**  
**D**  **16'1" (193")**  
 PRT-POL-SGL-16F1N
  - 4x**  
**E1**  **10' 10.25" (130.25")**  
 PRT-POL-DBL-10F10.25N
  - 4x**  
**E2**  **10' 10.25" (130.25")**  
 PRT-POL-DBL-10F10.25N
- Note: Poles D1 and D2 connect together to make Pole D. See Double Tube Set Up Instructions for further detail.
- 4x**  
**E**  **21'8.5" (260.5")**  
 PRT-POL-DBL-21F10.5N



## FITTINGS

- 4x**  
**(CRN)**  **Corner**  
 PUR-FIT-CRN
- 2x**  
**(6CR)**  **6-Way Crown**  
 PUR-FIT-6CR
- 6x**  
**(4ST)**  **Side Tee w/Ring**  
 PUR-FIT-4ST
- 10x**  
**(BPL)**  **Baseplate**  
 PUR-FIT-BPL

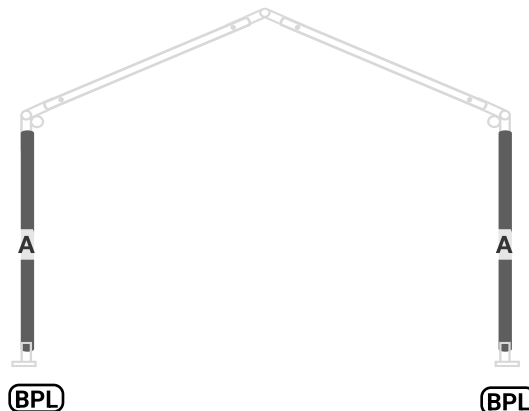

# Frame Tent Double Tube Assembly and Set Up



2350 East Mason Street, Green Bay, WI

| 920.431.0938

| sales@americantent.com

| www.americantent.com

## SET UP

RIVET SIDE

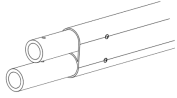

R-PIN SIDE



R-PIN



ENSURE THAT THE DOUBLE TUBE IS LINED UP PROPERLY WITH THE R-PIN HOLE FACING UP

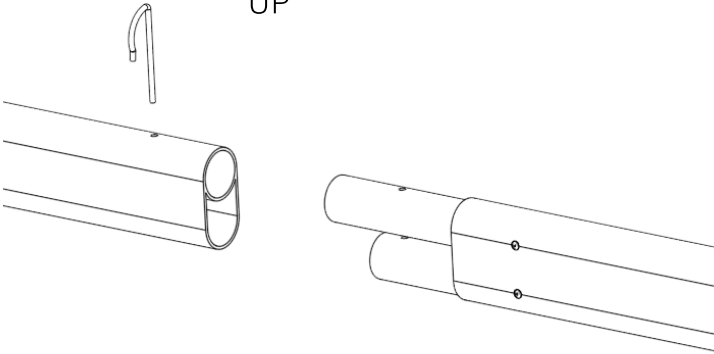

## FINAL ASSEMBLY

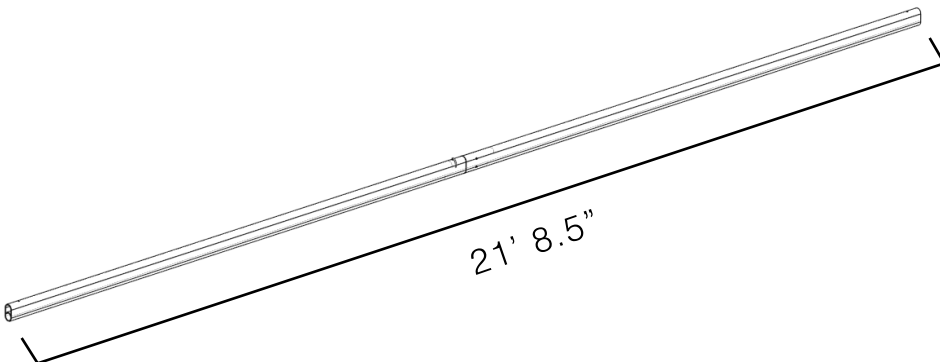

## TOP VIEW

SLIDE THE RIVET SIDE OF THE DOUBLE TUBE INTO THE R-PIN SIDE

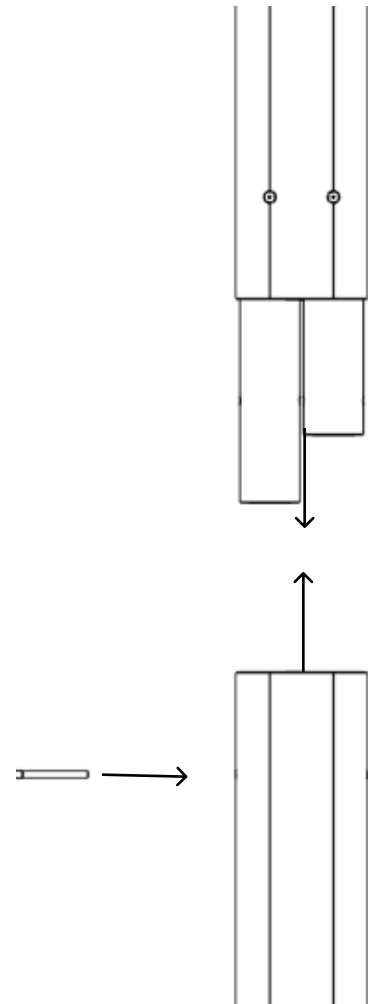

## FRONT VIEW

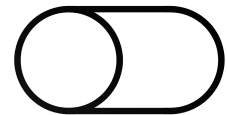

# 30x40 Frame Tent Roof, Cable Hardware & Staking Package



2350 East Mason Street, Green Bay, WI

920.431.0938

sales@americantent.com

www.americantent.com

## HARDWARE

- 50x** **Bail-Pin**  
PUR-PIN-BPN
- 12x** **R-Pin**  
PUR-PIN-RPN

Prevent damage to vinyl by ensuring that the open end of pin is positioned away from tent top

## ANCHORING

- 14x** **Stake**  
PUR-STK-STD
- 14x** **Ratchet Strap**  
KIT-RAT-2N

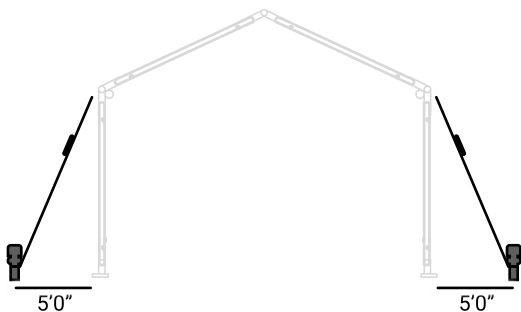
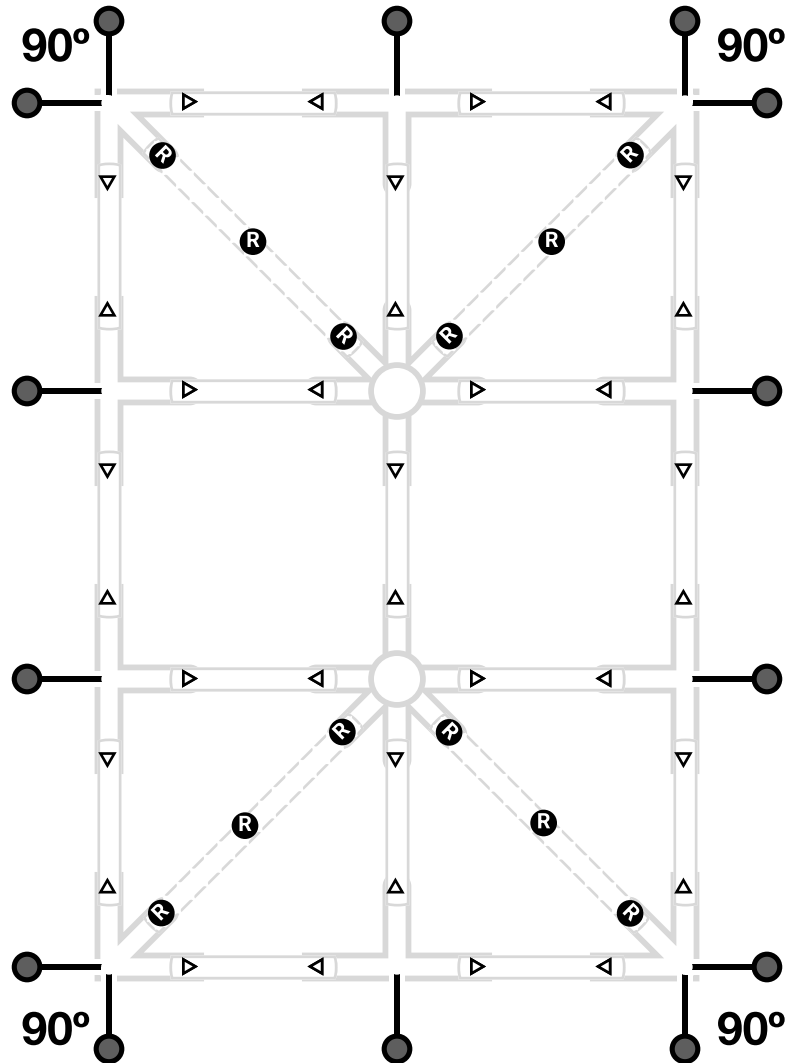

# SAFETY AND MAINTENANCE

## A

### Weather

Weather is very unpredictable; the installer or end user must use their judgment, common sense, and knowledge of conditions in order to install this tent safely. The installer is responsible for observing and anticipating weather conditions in regards to proper timing and method of installation. It is recommended that installation or removal of this tent be performed when the wind speed is less than 15 mph. ***If inclement weather is predicted with winds that exceed 38 mph in 6 second gusts, the tent must be evacuated as this type of weather can lead to property damage or personal injury.*** This is a temporary non-engineered structure.

#### The end user should be mindful of the following conditions:



#### Rain

Under certain conditions, water can collect on the tent fabric causing 'ponding', especially if the tent is not installed and tensioned correctly. Ponding can destroy the tent fabric and cause poles to sink into the soil. Additionally, saturated soil can cause stakes to lose their holding power.



#### Lightning

It is very dangerous to be under a tent during a lightning storm. Immediately leave the tent until the chance of lightning is no longer present.

## B

### Site Selection



**CRITICAL:** Call 811 a minimum of 3 working days prior to staking and have the site located & marked for utility locations

*Scan the QR code to find your local number.*

**Look carefully at the factors below when selecting a site:**

**Soil Conditions**– Adequate for anchoring

**Location**– Elevated, level, and clear of debris

**Space**– Check perimeter for space to anchor the tent

**Surface**– Grass, Gravel, Concrete, Asphalt, Wood

**Site Access**– Services and delivery can easily be achieved

**Check Overhead**– Look for any electrical lines or tree branches

**Underground Utilities**– Utilities must be located

*Use the 811 service to schedule a utility locate. If staking, be aware of underground electric, gas, oil, steam, telephone, CATV, water, sewer services. Have the site checked 3 days prior to staking.*

**Weather**– Monitor for weather conditions and evacuate if necessary.



#### Wind

Wind can cause the tension of the tent to change by loosening ratchet assemblies, pulling stakes, or causing poles to shift or sink. It is important to do routine maintenance checks and maintain proper tension on the tent top at all times.



#### Snow

Tents are not designed to carry any type of snow load. This product should not be used if snow has been allowed to accumulate on the tent.

## C

### Fire Safety

All vinyl fabric used in the production of our tents, sidewalls, and accessories is certified flame retardant per NFPA 701. These vinyl products are produced so that they are inherently flame retardant, and will never require additional applications of flame retardant chemicals.

Every section of fabric produced by American Tent contains a label identifying its flame retardancy characteristics and date produced.

#### Safety Checklist:

- When building or assembling anything above shoulder height, wear a hard hat
- Steel toe boots are recommended
- Inspect the site– look for overhead and underground obstructions
- Call your local utility to have the area marked ahead of time
- Inspect all ropes and tie lines and replace/repair as needed
- Inspect all poles and fittings to make sure there are no bends or breaks
- Replace or repair any items in poor condition
- CALL 8-1-1 BEFORE DOING ANY STAKING

## D

### Staking

The installer must follow local building and fire codes, and evaluate the site for proper staking and anchoring

If you are using stakes to secure your tent:

#### Step 1

Drive a stake approximately 5' away for 7' legs, 6' away for 8' legs, and so on. Stakes should have 6" or less of the head exposed. The deeper the stake is driven, the better the holding strength. Stakes driven vertically have better holding strength than stakes driven at an angle.

#### Step 2

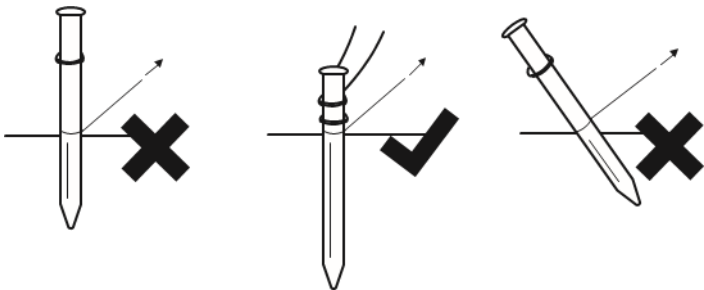

Before staking please contact your local utility 811 service and have the site checked. Please use this link to find the phone number needed by simply clicking on your state: <https://call811.com/811-In-Your-State> or dial 811 on your phone.

Attach a ratchet head to each stake. When attaching straps to the frame attach around the fitting not the poles

#### Loop Ratchet

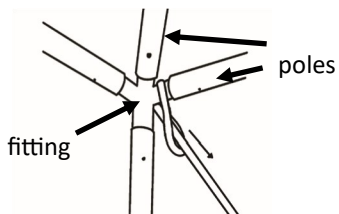

## E

### Maintenance

When applicable, go around the tent top and re-tension the alligator clips and straps followed by detailing (tucking the loose end of the strap into the clip)

- Check and re-tension all ratchets, straps, and cables
- Ensure stakes are in place and not pulling from ground

#### Caring for Your Tent:

The setup and take down process can make or break a tent—literally. Placing your tent tops directly on the ground is never a good idea. A tent on the ground is at extreme risk for pinholes, dirt, and other damage. Protect your tent from damage with a drop cloth.

Handle poles with care. Stack them on top of each other, but be sure to not drop or scrape them together.

When you are storing your tent for the long term, beware of extreme temperatures. Too hot and your tent can be damaged, too cold and your tent could crack. Extreme cold is especially dangerous for our clear vinyl. Freezing cold temperatures can cause it to crack. Store tents in a sheltered place where the temperature will stay above freezing.

Clean with gentle cleaners like American Tent “Tent Cleaner” or dish soap or powder laundry detergent. Avoid bleach, abrasive chemicals, and hard brushes.

# SET UP GUIDE for 30' Wide Atrium Frame Tent

Please know that your safety is our priority. Before setting up your tent, be sure to confirm with your local utility locating service that it is safe to set up your tent in your desired location. Be aware of potential weather conditions, and always evacuate your tent during periods of extraordinarily high winds or lightning.

## 1. Place the frame fittings and frame pipe on the ground.

Place the parts in their approximate locations based on the diagrams on pages 2 & 3. This ensures all parts are accounted for at the beginning of your tent set up.

## 2. Begin at the crown

Each protrusion on the crown has two holes. One hole is closer to the center (alignment hole), and the other is further down the protrusion (placement hole).

Before connecting a rafter, place a pin in the alignment hole. The pin prevents the rafter from moving too far onto the crown.

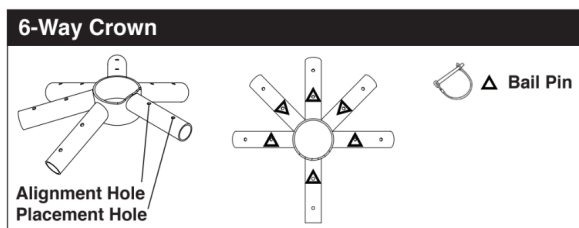

## 3. Connect the 6-Way Crown to Pole E.

A. With the crown 6CR laying on its side, slide poles E and D onto the crown 6CR stopping at the alignment pin at each indicated location.

B. Align the hole in pole E and D with the hole in the fitting and place the pin BPN through the pipe and fitting. Insert the pin from the top down.

C. Close the retainer around the pole and snap onto the end of the pin. Make sure the smooth end of the pin with the attached retaining clip is facing up and the "nail" end is facing down with the retaining clip snapped into place.

D. Remove the alignment pin

## 4. Connect Side Tee 4ST to Pole D.

A. With the crown and both pole D still laying on its side, place side tee 4ST onto Pole D using method above with alignment pin and bail pin BPN.

B. Repeat on adjacent Pole D.

C. Once assembled, rotate this assembly up so the crown is at the peak of the assembly.

D. Connect pole B to the 6CR. Repeat steps 3 and 4 to assemble the other end.

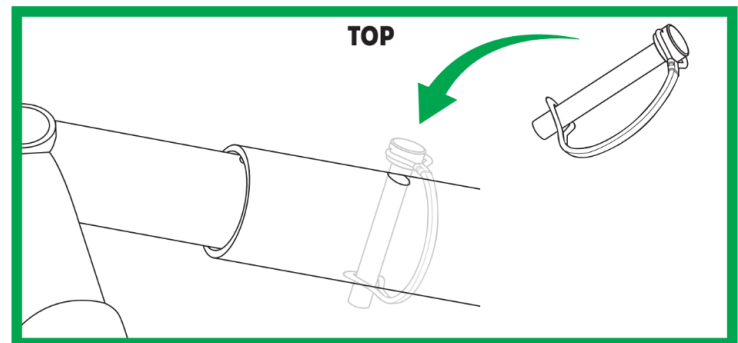
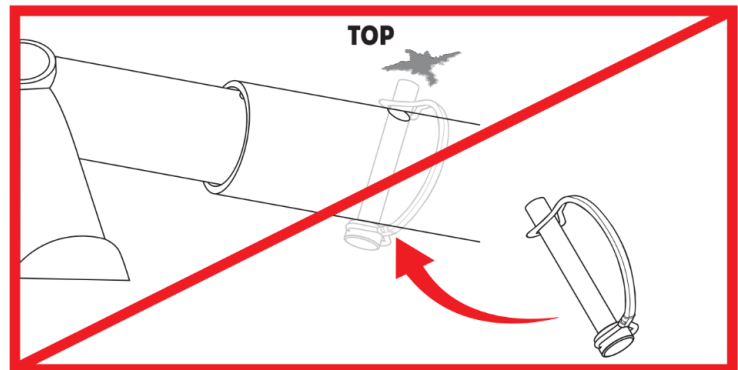

## 5. Connect all remaining poles and fittings

A. Beginning at a corner attach the corner fitting CRN to Pole C using the using method from step 2 with alignment pin and bail pin BPN.

B. Proceed around the frame attaching the Pole C to the corner fitting CRN and then to the previously installed side tee 4ST.

C. Continue installing the Pole C to the frame in the other positions until frame is completely assembled.

## 6. Loop end of each ratchet strap to fitting at each leg location.

When attaching straps to the frame attach around the fitting, not the poles

### Loop Ratchet

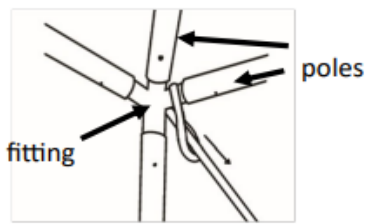

## 7. Unroll the tent top

Place tent top(s) on a drop cloth to protect the tent from dirt and abrasions

### If your tent is sectional, lace the tent together.

Line up each section (lace side is the bottom & grommet side is the top) so they overlap

Beginning at the middle work out to the side. Then repeat on other side of tent.

Pull the first lace up through the first grommet. Pull the second lace up through the second grommet and through the loop of the first lace. Repeat until you reach the end.

**Make sure you fold the rain flap over the laceline connecting the hook-and-loop fastener on either side as you lace the tent together**

Tie off at the end to secure the whole lace line.

Repeat to secure all other lace lines

**You are now ready to install the top onto the frame**

### Lacing Tent

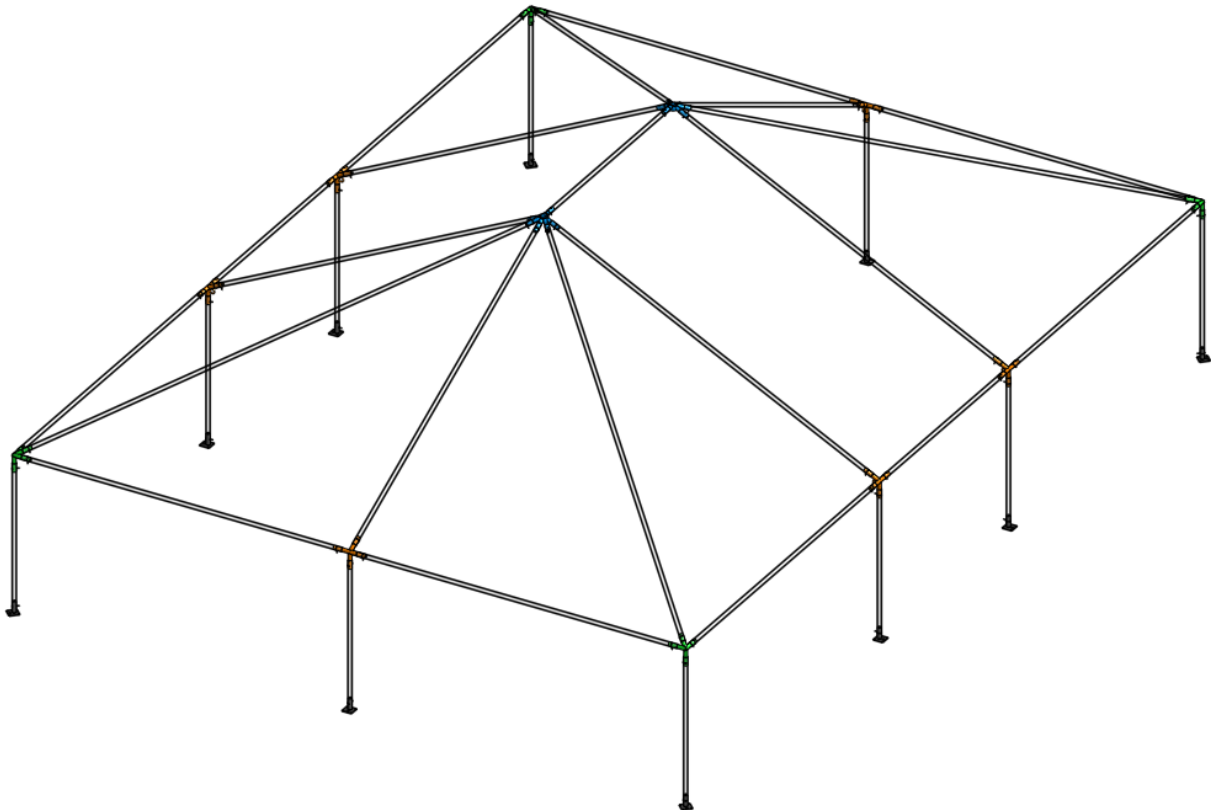
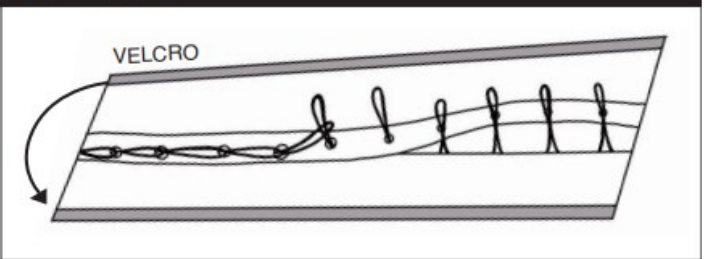



8. Carefully pull tent top over the frame, lifting up on the fabric to create air cushion under the tent top. Depending on the size of tent this may require additional help. ***\*\*Dragging the fabric top on the ground, or pulling hard over frame parts can damage, tear, and scratch the fabric. Use care when handling your tent top.***

9. Center tent top on frame by hiding the seams behind hip rafters & lining up the corner of the fabric with the corner of the frame.

Loosely fasten the alligator buckle straps at each side of the corners and at each laceline to secure the tent top to the frame.

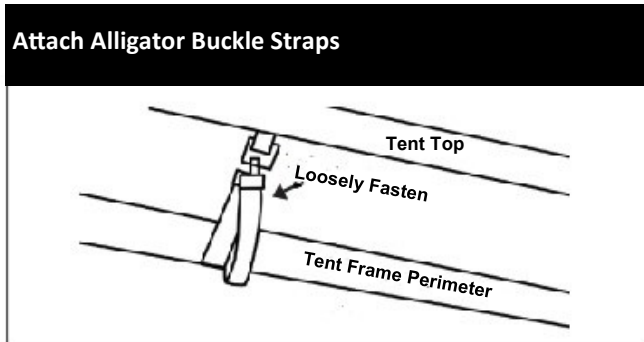

**You are now ready to lift your tent onto its legs**

10. Before you lift your tent attach the base plates ***BPL*** to the legs securing with a pin ***BPN***. Distribute the assembled legs around the tent in their approximate locations.

11. Lift the downwind side of the frame, keeping it level along the length of the tent to avoid bending the poles. No matter what the wind conditions are, always lift the downwind side of the tent first. This prevents the wind from catching the tent & flipping it over. Do not lift one corner at a time, it is better to lift the entire side. Frame Jacks make lifting the tent much easier. Contact American Tent for more details.

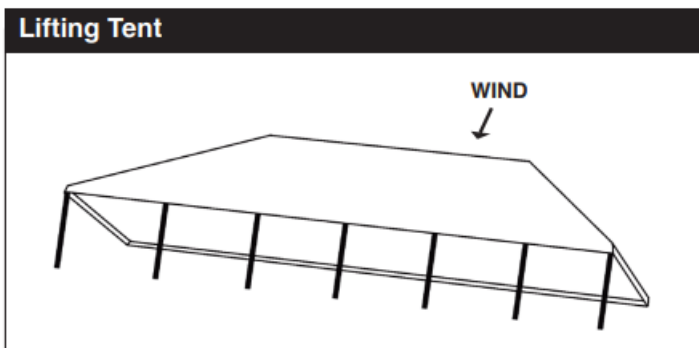

12. Attach all leg poles to the lifted side making sure the pin ***BPN*** is installed from the outside in.

13. Repeat the lifting and leg installation on the opposite side of the tent.

14. Install the legs on each end of the tent.

15. Fasten the rest of the alligator straps around the perimeter tubing. Do this by tugging on the valance to keep the material taut while firmly pulling the straps. Tension the top evenly to prevent undue wear and tear as well as wrinkles

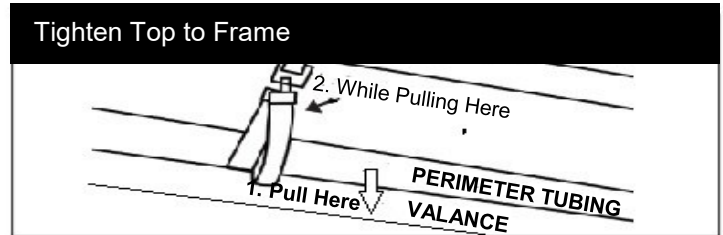

### Anchoring Your Tent

16. Place stakes 5' out from each leg; drive stakes into the ground so that 6" or less of the stake is above ground.

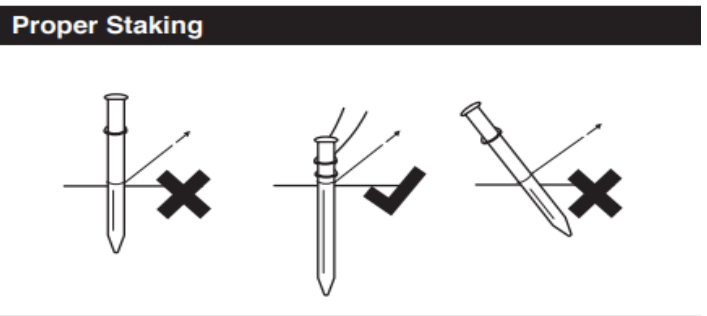

### 17. Attach ratchet straps to the stakes .

Attach the ratchet with loop strap to stakes by turning the 6" loop at the end of the ratchet inside out and pulling the strap through the loop. This will create a slipknot to pull tight over the stake. Take the loop strap attached to the tent and pull it through the slot of the ratchet. Keep the ratchet buckle handle facing up at all times. Pull the loop strap back towards the tent until taut, then lock the web into place using the ratchet handle. Tighten ratchet straps by holding strap with one hand and cranking ratchet handle with the other.

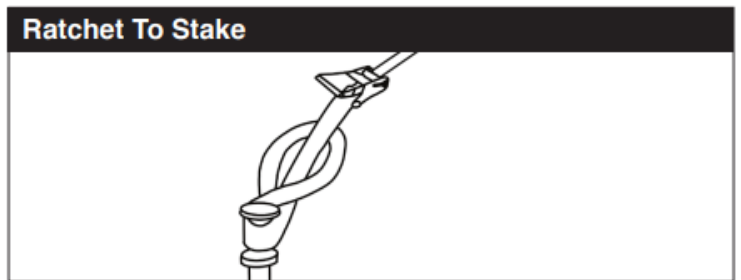

## Striking and Storage

### Striking Your Tent

1. Loosen ratchet strap assemblies.
2. Remove side and end legs.
3. Unfasten all alligator straps except the two at each corner and the ones at the lace line.
4. Remove 2 corner legs from one side and carefully set the tent frame on ground.
5. Repeat with the opposite side.
6. Unfasten the rest of the alligator straps until all are completely disconnected.
7. Roll out your drop cloth.
8. Remove the tent top from the frame, landing it on the drop cloth.
9. If your tent has laces, unlace your tent top. Untie the knot and unlace the tent top section while opening the rain flap.
10. Fan fold and tightly roll the tent top pieces. For the longevity of your tent, take down, disassemble, roll and bag your tent only when completely dry and free from leaves or any other foreign matter.
11. Place your rolled tent top into its bag.
12. Fold and roll up the drop cloth.
13. Disassemble all of the corner & side tee fittings by removing the pins, and sliding the tubing off of the fittings. Work from the perimeter of the frame inward, finishing at the crown.
14. Remove all stakes.

### Storing Your Tent

This process begins at the tent strike. You need a drop cloth to protect your tent top as well as to keep it clean and dry prior to storage.

Drop cloths reduce the likelihood of:

- Pinholes
- Dirt & grass stains
- Mystery residue

**Always store tents clean and dry in a cool dry environment**

#### Bag it

If your tent was supplied with a bag, put your tent back into the bag. This will keep it protected from the elements.

#### Storing Sidewalls

Fan folding and flat stacking is the best way to store sidewall, again its very important to store all vinyl clean and dry in a cool dry environment .

#### Cleaning

When washing your tent make sure the soap you use is safe for your tent fabric. Use American Tent "Tent Cleaner" or gentle cleaners like dish soap or mild laundry detergent. Completely avoid Bleach, Abrasive Chemicals, any cleaner with Petroleum Distillates, and hard brushes. Once tents are completely dry they can be folded, rolled and bagged for next use.

# ADDITIONAL PRODUCT ASSEMBLY

## SIDE WALL

Carefully unfold the sidewall on a drop cloth. The fold should be approximately 24" wide by the height of the tent.

Place this fold over your shoulder with the clip side to your front, letting the bottom of the sidewall drape to your back.

Before attaching the first clip make sure the open side of the clips are facing into the tent

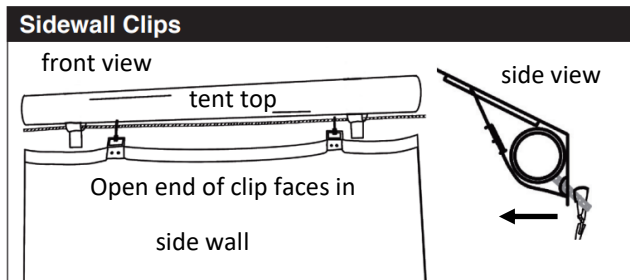

Attach the first clip onto the sidewall rope and then walk slowly, attaching every third clip. Once every third clip is attached and the sidewall is hanging in the desired location go back and attach the remaining clips.

Use the side release buckles on both ends to either connect another sidewall or secure around a pole.

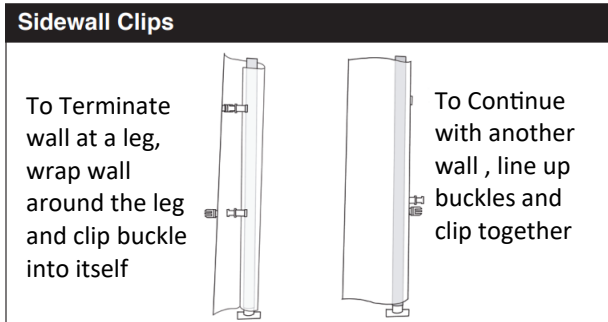

Fan folding is the best method for storing your sidewalls. Make sure they are clean and dry before folding and storing.

## RAIN GUTTER

When installing two tents next to each other use a rain gutter to direct the rain off the tents.

Begin by moving the tents approximately 8" apart from each other.

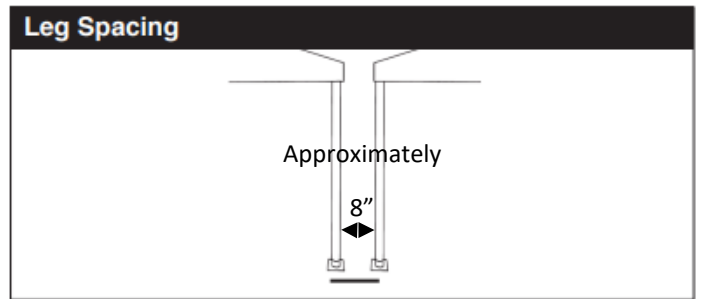

Similar to sidewall, the rain gutter will attach to the sidewall rope.

Attach the clips from one side of the gutter to the sidewall rope on the first tent.

After attaching to the first tent, repeat the process on the second tent

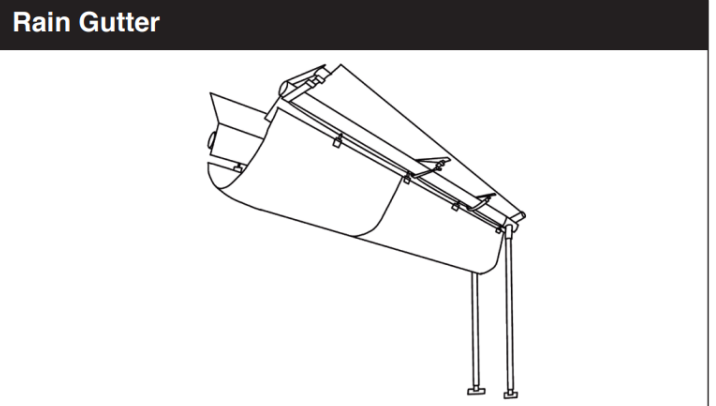

### Need Help?

Check out our YouTube channel for instructional videos and how-tos! Or give us a call at 920-431-0938



# 30x40 Frame Tent Giffy Package



2350 East Mason Street, Green Bay, WI

920.431.0938

sales@americantent.com

www.americantent.com

## ANCHORING

- 
**20x** Giffy Barrel  
PUR-GIF-BRL
- 
**10x** Double Giffy Plate  
PUR-GIF-PLA-DBL
- 
**10x** Double Hardware Kit  
KIT-HDW-DBL
- 
**20x** Ratchet Strap  
KIT-RAT-2N

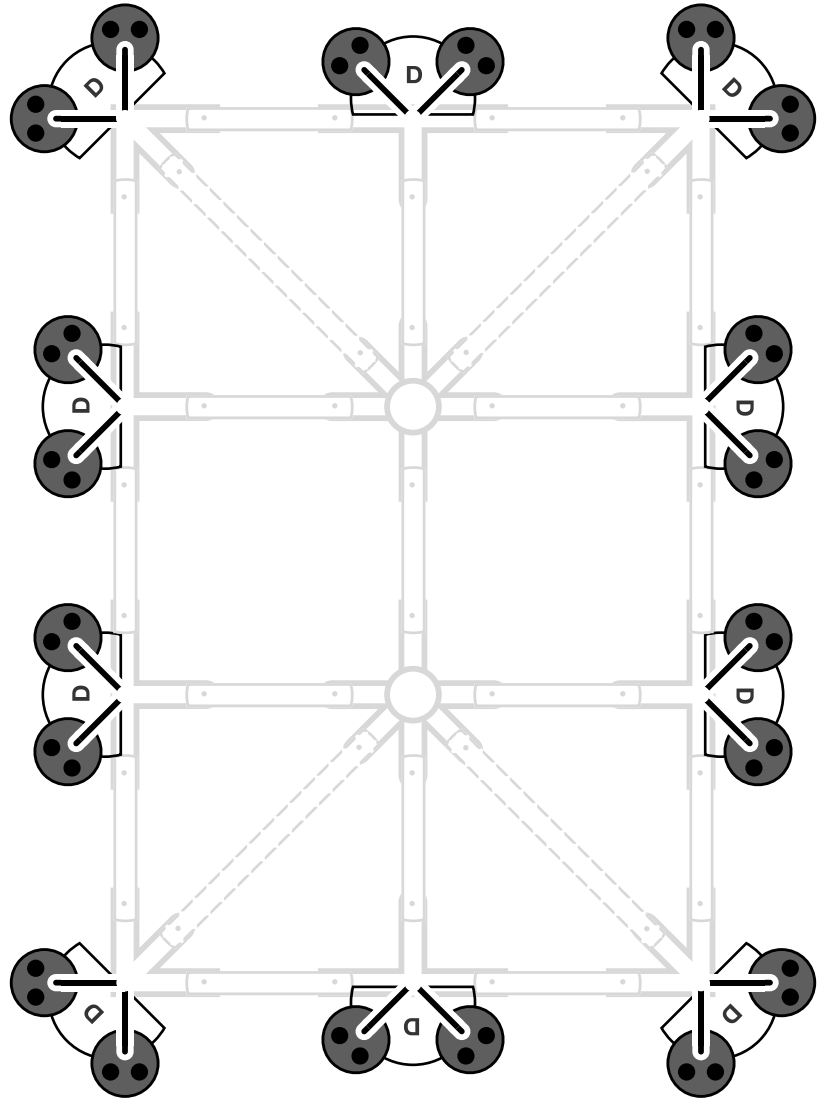

Attach Giffy Plates to underside of barrel using hardware kits; Install to the bottom of each leg

# ADDITIONAL PRODUCT ASSEMBLY

## GIFFY BALLASTS

1. Turn the barrel upside down to connect the mounting plate.

### Giffy Parts

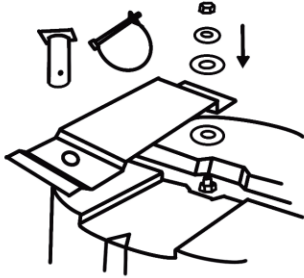

2. Assemble the hardware for the Giffy barrel using the following sequence:

- Place a large washer over the nut and bolt.
- Place the plate over the washer.
- Place another large washer followed by a smaller washer, then place and tighten the nut.
- Flip the barrel right side up and insert the base plate through the hole in the plate.
- Place a pole over the base plate that has been inserted into the plate. Put pin through pole and base plate and secure

### Base Plate

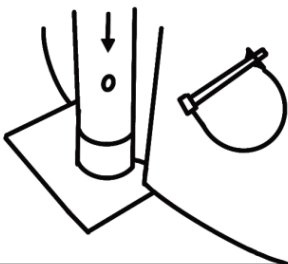

### Ratchet Loop

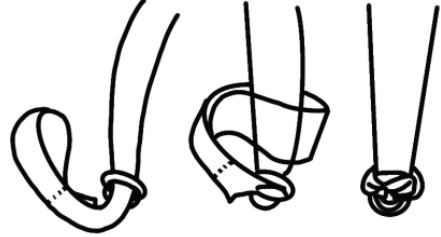

3. Connect the strap to the eye bolt in the bottom of the barrel.

- Pull looped end of the strap through the eye bolt. Take the other end of the strap and pull it all the way through the loop. Pull long end tight to secure strap to eye bolt.
- Pull the strap through the cover slot.

### Cover Slot



4. Connect the opposite end of the strap to the top of the fitting. Put all ratchet straps around the fittings, never around the tent frame pipes. This forms a strong triangle.

5. Fill the barrel with water.

# 30' x 40' Ameritrac Kedar Safety and Tent Setup Guide



Thank you for your recent purchase from American Tent. The following procedures will help you through your installation. If you ever run into problems with the installation of your American Tent give one of our sales/service professionals a call at 920.431.0938. Other product specific information, contact information, diagrams, and installation guides are available on our web site at [www.americantent.com](http://www.americantent.com).

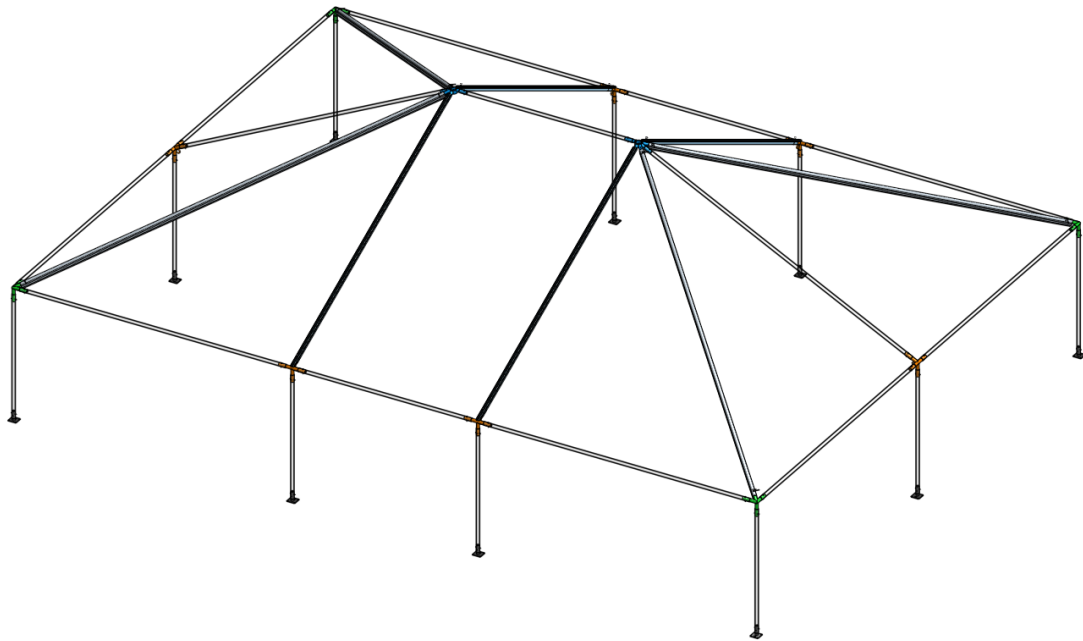

## REQUIRED EQUIPMENT

Sledge Hammer



Drop Cloth



3-5 People



Pull Rope



Step Ladder



# 30x40 Ameritrac Frame Tent Roof & 7' Leg Package: Poles



















2350 East Mason Street, Green Bay, WI

920.431.0938

sales@americantent.com







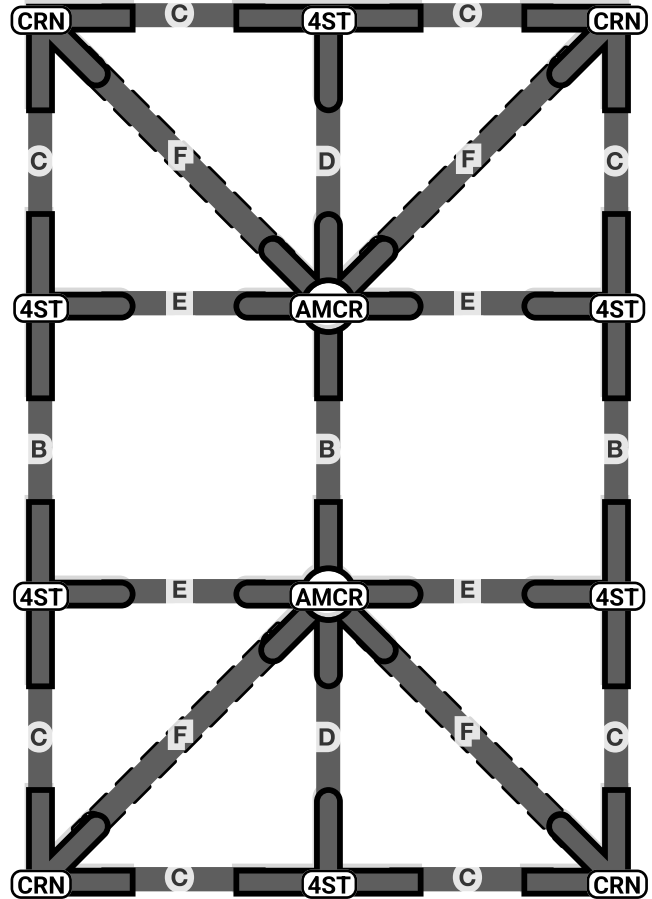

www.americantent.com

## POLES

- 
**10x A**  **6'8" (80")**  
 PRT-POL-SGL-6F8N
  - 
**3x B**  **9'4" (112")**  
 PRT-POL-SGL-9F4N
  - 
**8x C**  **14'4" (172")**  
 PRT-POL-SGL-14F4N
  - 
**2x D**  **16'1" (193") (Standard)**  
 PRT-POL-SGL-16F1N
  - 
**4x E**  **16'1" (193") (Ameritrac)**  
 PRT-POL-SGL-16F1N
  - 
**4x F1**  **10' 10.25" (130.25")**  
 PRT-POL-DBL-10F10.25N
  - 
**4x F2**  **10' 10.25" (130.25")**  
 PRT-POL-DBL-10F10.25N
- Note: Poles F1 and F2 connect together to make Pole F. See Double Tube Set Up Instructions for further detail.
- 
**4x F**  **21'8.5" (260.5")**  
 PRT-POL-DBL-21F10.5N



## FITTINGS

- 
**4x (CRN)**  **Corner**  
 PUR-FIT-CRN
- 
**2x (AMCR)**  **Ameritrac Crown**  
 PUR-FIT-6CR
- 
**6x (4ST)**  **Side Tee w/Ring**  
 PUR-FIT-4ST
- 
**10x (BPL)**  **Baseplate**  
 PUR-FIT-BPL

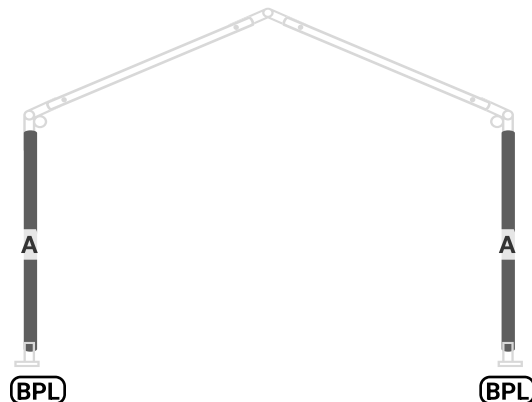

# 30x40 Ameritrac Frame Tent Roof, Hardware, & Staking Package



2350 East Mason Street, Green Bay, WI | 920.431.0938 | sales@americantent.com | www.americantent.com

## HARDWARE

46x Bail-Pin  
PUR-PIN-BPN

12x R-Pin  
PUR-PIN-RPN

8x Ameritrac-Pin  
PUR-PIN-RPN

Prevent damage to vinyl by ensuring that the open end of pin is positioned away from tent top

## ANCHORING

14x Stake  
PUR-STK-STD

14x Ratchet Strap  
KIT-RAT-2N

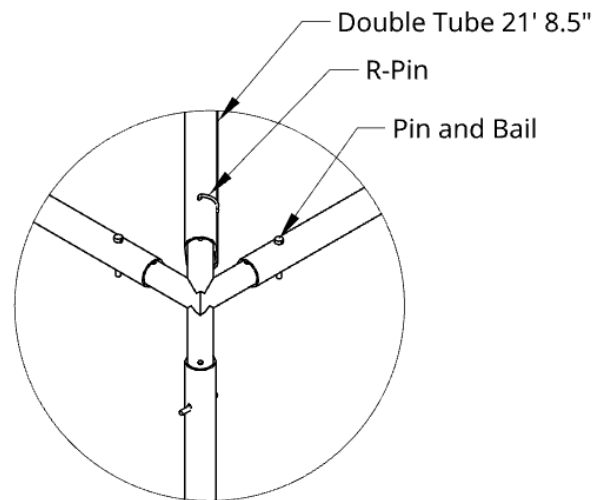
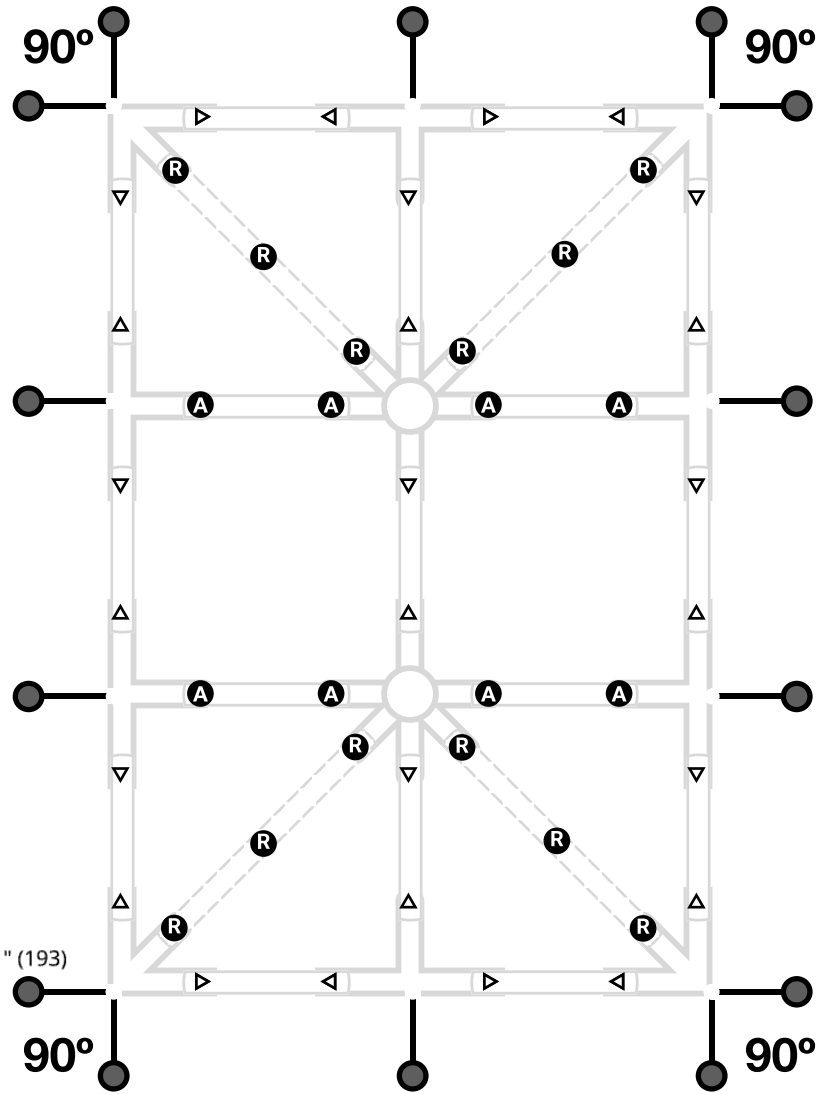
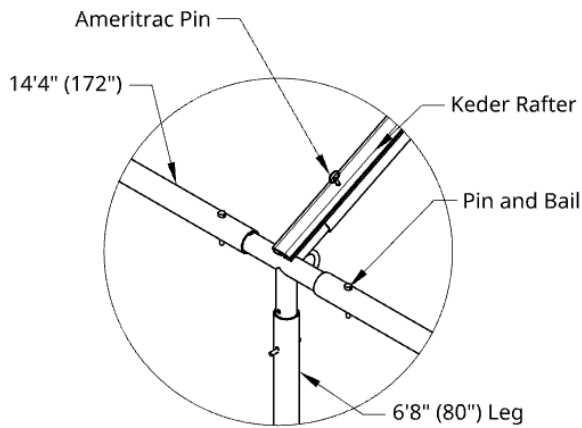



# SET UP GUIDE for 30' Wide Ameritrac Frame Tent

Please know that your safety is our priority. Before setting up your tent, be sure to confirm with your local utility locating service that it is safe to set up your tent in your desired location. Be aware of potential weather conditions, and always evacuate your tent during periods of extraordinarily high winds or lightning.

## 1. Place the frame fittings and poles on the ground.

Put them in their approximate locations based on the diagrams on pages 15-16. This ensures all parts are accounted for at the beginning of your tent set up.

## 2. Begin at the crown. Connect Ameritrac Crown to Pole E.

- With the crown AMCR laying on its side, slide pole E onto the crown AMCR aligning the tongue with the pole.
- Align the hole in pole E with the hole in the fitting, and place the Ameritrac pin through the pipe and fitting. Insert pin from the top down.
- Repeat on the pole E position directly across from this pole.

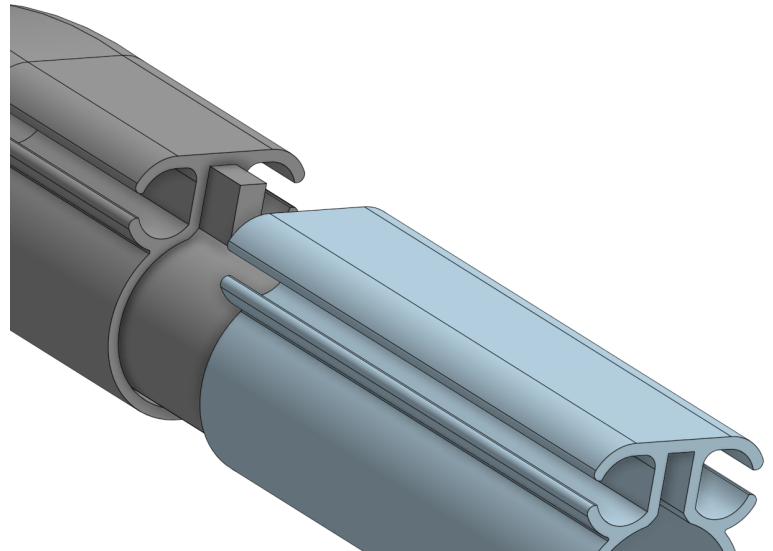

## 3. Connect Side Tee 4ST to Pole E.

- With the crown and both pole E still laying on its side, place side tee 4ST onto Pole E. Insert the bail pin from the top down through both pipe and fitting.
- Repeat on adjacent Pole E.
- Once assembled, rotate this assembly up so the crown is at the peak of the assembly
- Repeat on the pole E position directly across from this pole.

## 4. Connect Both Pole D and all of Pole F to the Ameritrac crown.

- Place Pole D onto their correct protrusions using bail pin
- Repeat on the 2 remaining protrusions going to the corners with Pole F.
- Connect Pole B to the last protrusion.

## 5. Connect all remaining poles and fittings

- Beginning at a corner, attach the corner fitting CRN to Pole F using the bail pin BPN.
- Proceed around the frame attaching the Pole C to the corner fitting CRN and then to the previously installed side tee 4ST.
- Continue installing the Pole C to the frame until the ends frame is completely assembled. Use Pole B to connect the 2 ends of the frame together as shown.

## 6. Loop end of each ratchet strap to fitting at each leg location

When attaching straps to the frame attach around the fitting not the poles

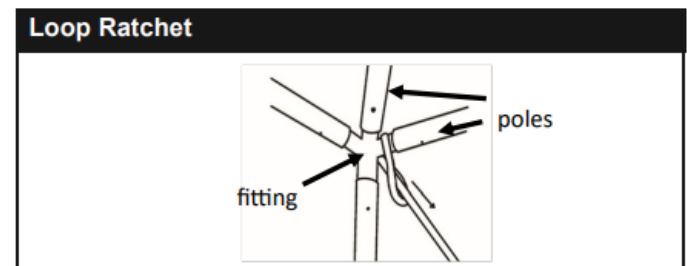

# SET UP GUIDE for 30' Wide Ameritrac Keder Frame Tent

## 7. Unroll the tent top

Place tent top(s) on a drop cloth to protect the tent from dirt and abrasions, place the top adjacent to the frame with the Keder aligned with the track in pole D.

Insert the Keder into the track approximately 3 inches

Carefully throw the pull rope over the frame and attach the snap hook on the rope to the O ring on the tent top

**You are now ready to install the top onto the frame**

8. Using the pull rope carefully pull tent top through and over the frame. Depending on the size of tent this may require additional help. ***\*\*Dragging the top fabric on the ground, or pulling hard over frame parts can damage, tear, and scratch the fabric. Use care when handling your tent top.***

10. Center the tent top on the frame by hiding the seams behind hip rafters & lining up the corner of the fabric with the corner of the frame.

Loosely fasten the alligator buckle straps at each side of the corners and at each laceline to secure the tent top to the frame.

9. Before you lift your tent, attach the base plates **BPL** to the legs securing with a pin **BPN**. Distribute the assembled legs around the tent in their approximate locations.

flipping it over. Do not lift one corner at a time, it is better to lift the entire side. Frame Jacks make lifting the tent much easier. Contact American Tent for more details on this tool.

11. Attach all leg poles to the lifted side making sure the pin **BPN** is installed from the outside in.

12. Repeat the lifting and leg installation on the opposite side of the tent.

13. Install the legs on each end of the tent.

14. Fasten the rest of the alligator straps around perimeter tubing. Do this by tugging on the valance to keep the material taut while firmly pulling the straps. Tension the top evenly to prevent undue wear and tear as well as wrinkling in the tent top fabric.

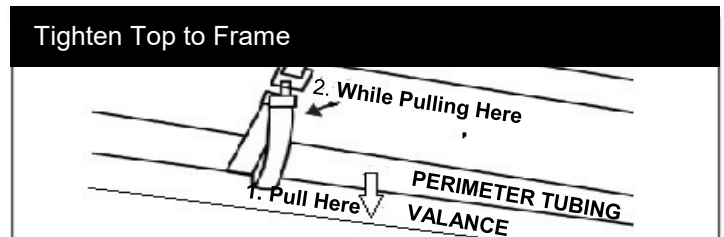

## Anchoring Your Tent

15. Place stakes 5' out from each leg; drive stakes into the ground so that 6" or less of the stake is above ground.

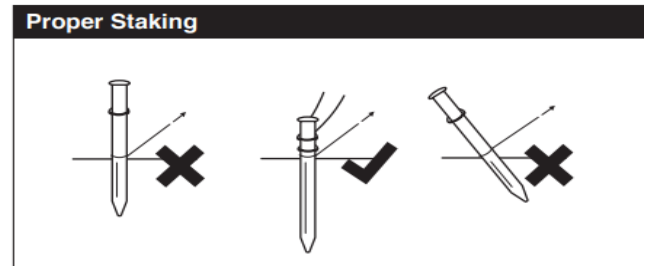

16. Attach ratchet straps to the stakes .

Attach the ratchet with loop strap to stakes by turning the 6" loop at the end of the ratchet inside out and pulling the strap through the loop. This will create a slipknot to pull tight over the stake. Take loop strap attached to the tent and pull it through the slot of the ratchet. Keep ratchet buckle handle facing up at all times. Pull loop strap back towards tent until taut, then lock the web into place using the ratchet handle. Tighten ratchet straps by holding strap with one hand and cranking ratchet handle with the other.

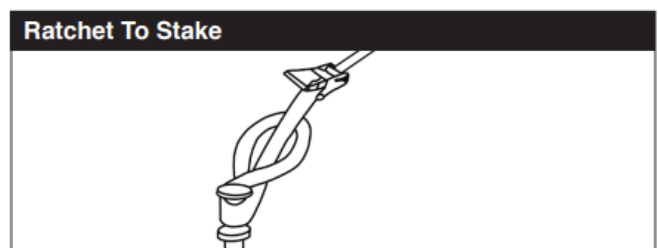

## Attach Alligator Buckle

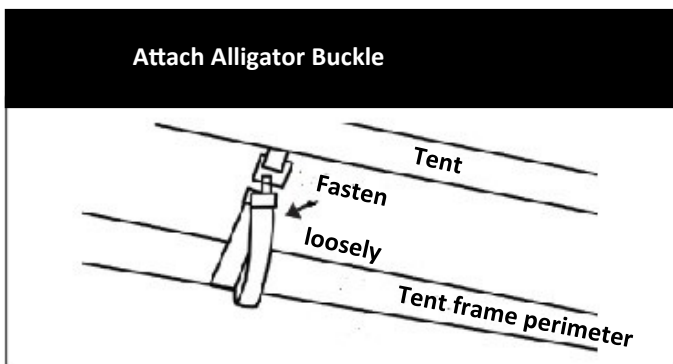

**You are now ready to lift your tent onto its legs**

10. Lift the downwind side of the frame, keeping it level along the length of the tent to avoid bending the poles. No matter what the wind conditions are, always lift the downwind side of the tent first. This prevents the wind from catching the tent &

## Lifting Tent

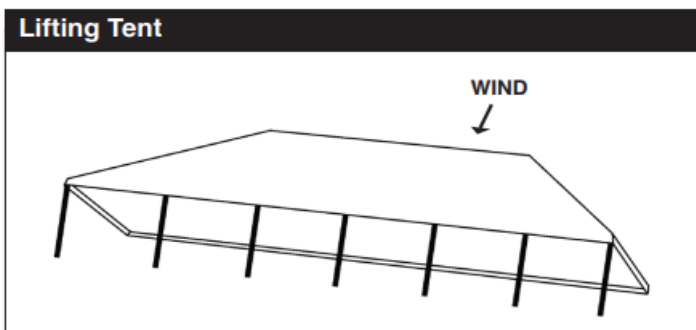

# TERMS & CONDITIONS

## TERMS AND CONDITIONS OF SALE

1. **Terms Control/Rejection of Conflicting Terms.** All sales are governed by these terms, and by placing an order, submitting payment, or providing Seller with a Purchase Order, Buyer agrees to these terms. Seller's offer to sell Buyer the Goods is conditioned on this acceptance. All other terms are rejected, including any terms included on any Purchase Orders from Buyer to Seller.
2. **Payment Terms.** Unless otherwise agreed in writing by Seller and Buyer, all order shall be prepaid in full before Seller ships any product subject to these Terms and Conditions (the "Goods"). If Buyer pays by check other than a cashier's check, Seller may delay shipment for a reasonable period as determined in Seller's sole discretion.
3. **Taxes.** Prices do not include sales, use, VAT, excise and other taxes or governmental charges with respect to the production, sale, distribution or delivery of the Goods. The final invoice amount includes all applicable taxes or governmental charges. Seller is responsible for proper remittance of all such taxes or governmental charges.
4. **Shipping.** Unless otherwise agreed in writing by Seller and buyer, shipment terms are F.O.B. Origin, Freight Prepaid and Add. Choice of carrier shall be in Seller's sole discretion.
5. **Returns/Cancellations.** All sales are final upon pickup or shipment from Seller's facility. Seller will not accept returns of any of the Goods except under certain circumstances as set forth in an authorized Returned Merchandise Authorization (RMA), which must include pictures of the tent purchased. RMA forms are available upon request. Seller holds sole discretion of authorization. Orders for Goods may be cancelled at any time prior to pick up or shipment from Seller's facility; provided, however, that any such cancellation shall result in a restocking fee of twenty-five percent (25%) of the original purchase price of the cancelled Order for having reserved a spot on our production schedule. This applies even for those orders that are via PO.
6. **Returns.** All sales are final. Seller will not accept returns of any of the Goods except under certain circumstances as set forth by an authorized RMA, which must include pictures of the tent erected. RMA forms are available upon request. Seller holds sole discretion of authorization.
7. **Force Majeure.** Seller will not be liable for any delay of its performance hereunder if the delay is directly or indirectly caused by or arises from fires, floods, terrorism, accidents, riots, war, government interference, embargoes, strikes, shortage of labor, materials or supplies, inadequate transportation facilities or any other cause beyond Seller's control.
8. **Warranty.** All tents are sold as is, and no warranties are given.
9. **Damages.** Any damages that occur as a result of improperly ballasted or improperly staked tents are the sole responsibility of the Buyer. Buyer acknowledges that tent must be ballasted or staked per the recommendations made by Seller. Seller will not be responsible for material, personal, or financial loss.
10. **Commitment to Cure.** We are committed to our workmanship and our customers. We will make right any issues with the tent top and/or parts prior to their initial use. Customers must bring any and all issues to our attention within 14 days of receipt of goods. We cannot honor requests for cure after 14 days of receipt.
11. **Limitation of Damages.** Seller shall not be liable for indirect, incidental, consequential, exemplary or punitive damages resulting from or arising in connection with any act or omission of Seller relating to any breach of these Terms and Conditions or relating in any way to the design, manufacture, delivery or use of the Goods. Seller's liability, regardless of grounds, shall be limited to the amount paid by Buyer for the Goods.
12. **Limitation of Actions.** Any statute of limitations notwithstanding, no claim shall be filed or brought against Seller for any breach of these terms and conditions after two (2) years of the date Buyer receives the Goods.
13. **Installation and Service.** Seller shall not be required to install, service or provide any on-site preparation or installation of any of the Goods. If Seller provides instruction to Buyer generally or specifically regarding any methods of installation, such instruction is gratuitous and is not to be considered a part of these Terms and Conditions.
14. **Nature of Goods as Temporary Structures.** Each of the Goods constitutes a temporary structure or part of a temporary structure that is not intended to meet any building or other codes. Buyer uses the Goods at his/her/ its sole risk.
15. **Modifications.** These Terms and Conditions may not be amended, modified, terminated or repudiated, in whole or in part, except in writing signed by Seller and Buyer.
16. **Remedies Not Exclusive.** No remedy of Seller provided herein is exclusive of any other remedy available to Seller.
17. **Assignment.** Buyer cannot assign any rights, duties or obligations hereunder without Seller's prior written consent.
18. **Governing Law and Venue.** These Terms and Conditions shall be governed by, and construed in accordance with, the laws of the State of Wisconsin, and any legal proceeding with regard to these Terms and Conditions or the Goods shall be brought in the Circuit Court for Brown County, Wisconsin. Buyer hereby waives any claims of forum non conveniens or any other similar claims.
19. **Cost of Collection.** Buyer shall be liable to pay Seller for all costs associated with any breach of these Terms and Conditions by Buyer, including Seller's actual attorney's fees.
20. **Authority of Signers.** Each person accepting these Terms and Conditions represents and warrants that he/she has been duly authorized to do so.
21. **Counterparts & Facsimile Signatures.** These Terms and Conditions may be signed in counterparts. Facsimile and electronic signatures shall have the same effect as originals. Placing and paying for an order online also acknowledges and agrees to these Terms & Conditions.
22. **Pickup Orders:** Customers may request to pick up purchased products from American Tent's facility in Green Bay, Wisconsin. Upon such request, the customer must schedule a pick-up time during American Tent's regular warehouse hours, which are 7:00 a.m. to 4:00 p.m., Monday through Thursday. Loading time will vary based on order size and method of transportation. Orders that are not picked up within five (5) business days of the scheduled pick-up date (Fridays excluded) may be subject to storage fees. Customers must mark any product shortages, damages, or other issues with the order prior to departure from American Tent's facility. The customer's signature on an American Tent acknowledgement receipt confirms that all proper products and quantities have been received and that such products are free of visible damage. Unless otherwise agreed in writing, the Customer is responsible for all product loading and providing or retaining transportation for all products placed for pick-up.