

40'x60' Frame Tent Safety & Set Up Guide



2350 East Mason Street, Green Bay, WI | 920.431.0938 | sales@americantent.com | www.americantent.com

Notice

The instructions in this guide cannot cover all possible conditions and situations that can possibly occur. It must be understood by the user that common sense and caution are factors which cannot be built into this product, but must be supplied by the installer and/or user.

INDEX

Page 1.....	Tent & Equipment
Page 2.....	Diagrams & Parts
Page 5.....	Safety & Maintenance
Page 6.....	Terms & Conditions
Page 8.....	Set Up
Page 11.....	Striking
Page 13.....	Additional Assembly

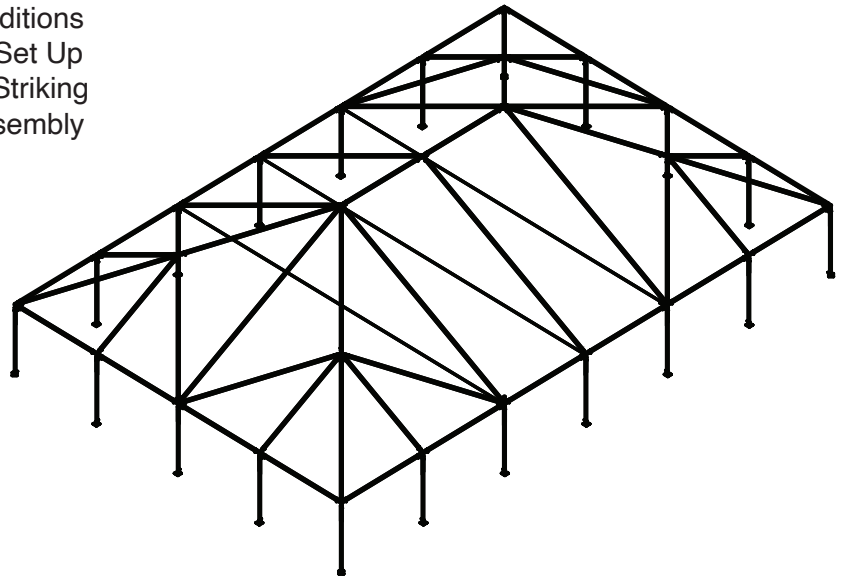

REQUIRED EQUIPMENT

Sledge Hammer



Drop Cloth



6-8 People



40x60x7 Frame Tent

Roof, Cable Hardware & Staking Package



2350 East Mason Street, Suite 8, Green Bay, WI 54302 | 920.431.0938 | sales@americantent.com | www.americantent.com

HARDWARE

124x Bail-Pin
PUR-PIN-BPN

24x R-Pin
PUR-PIN-RPN

Prevent damage to vinyl by ensuring that the open end of pin is positioned away from tent top

3x 40' Cable
PRT-CBL-40F

Install cables before the legs and tent top

ANCHORING

28x Stake
PUR-STK-STD

28x Ratchet Strap
KIT-RAT-2N

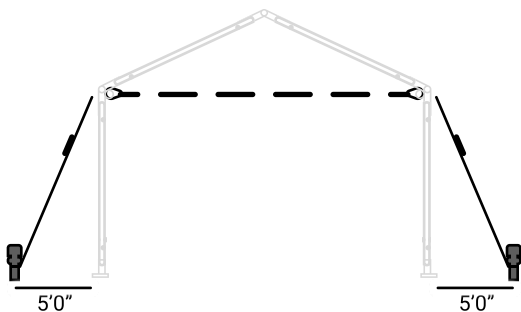
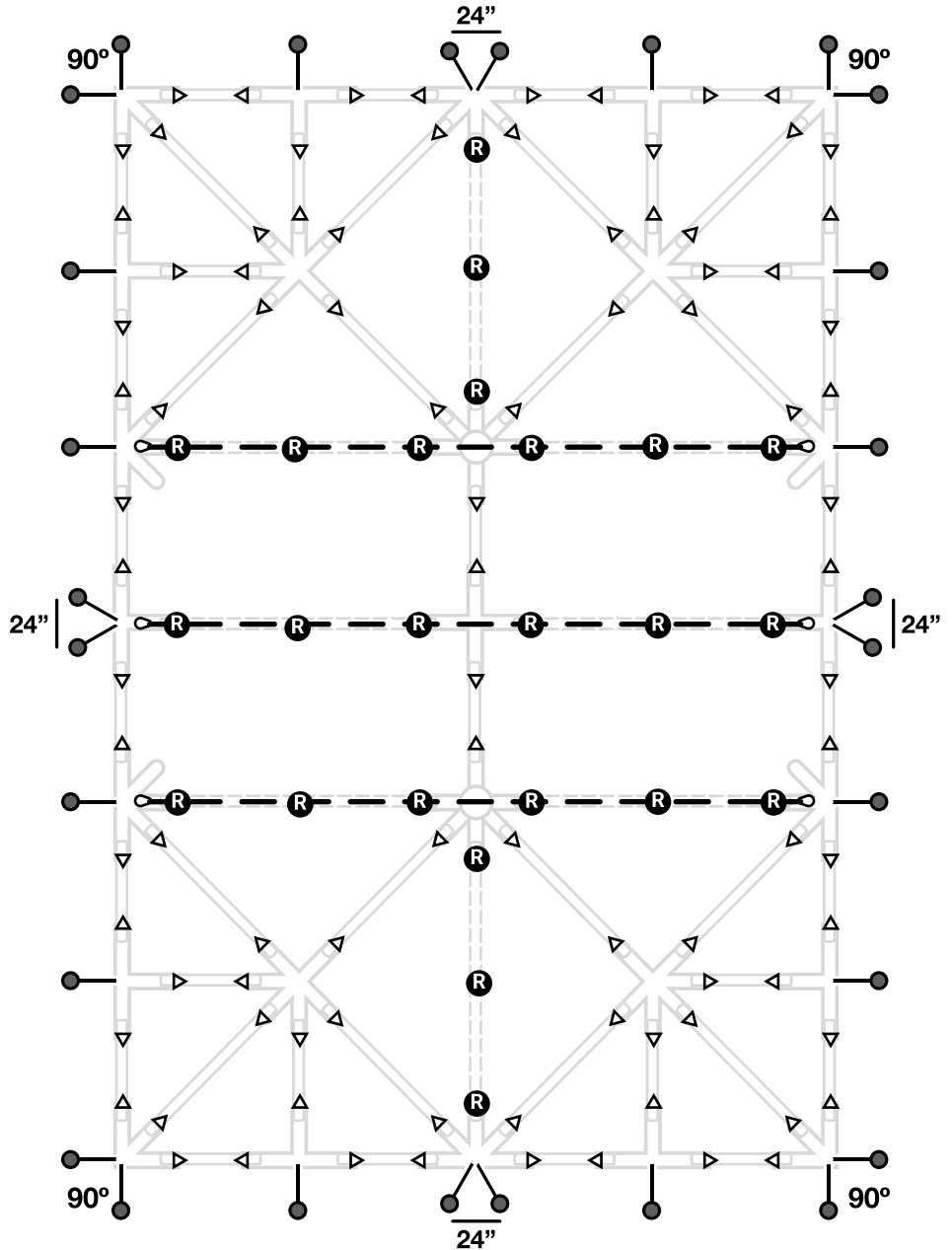









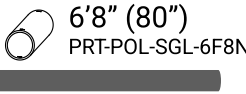

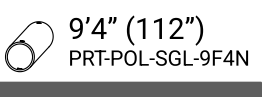

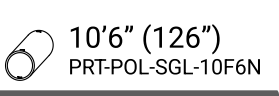
40x60 Frame Tent Roof & 7' Leg Package: Poles

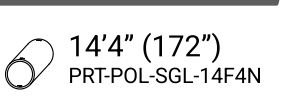

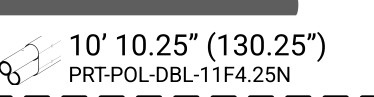
2350 East Mason Street, Suite 8, Green Bay, WI 54302 | 920.431.0938 | sales@americantent.com | www.americantent.com

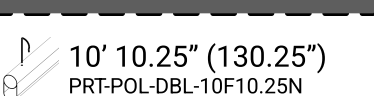
POLES

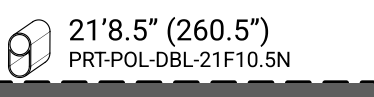
- 
20x A  **6'8" (80")**
 PRT-POL-SGL-6F8N
 - 
22x B  **9'4" (112")**
 PRT-POL-SGL-9F4N
 - 
8x C  **10'6" (126")**
 PRT-POL-SGL-10F6N
 - 
16x D  **14'4" (172")**
 PRT-POL-SGL-14F4N
 - 
8x E1  **10' 10.25" (130.25")**
 PRT-POL-DBL-11F4.25N
 - 
8x E2  **10' 10.25" (130.25")**
 PRT-POL-DBL-10F10.25N
- Note: Poles E1 and E2 connect together to make Pole E. See Double Tube Set Up Instructions for further detail.
- 
8x E  **21'8.5" (260.5")**
 PRT-POL-DBL-21F10.5N

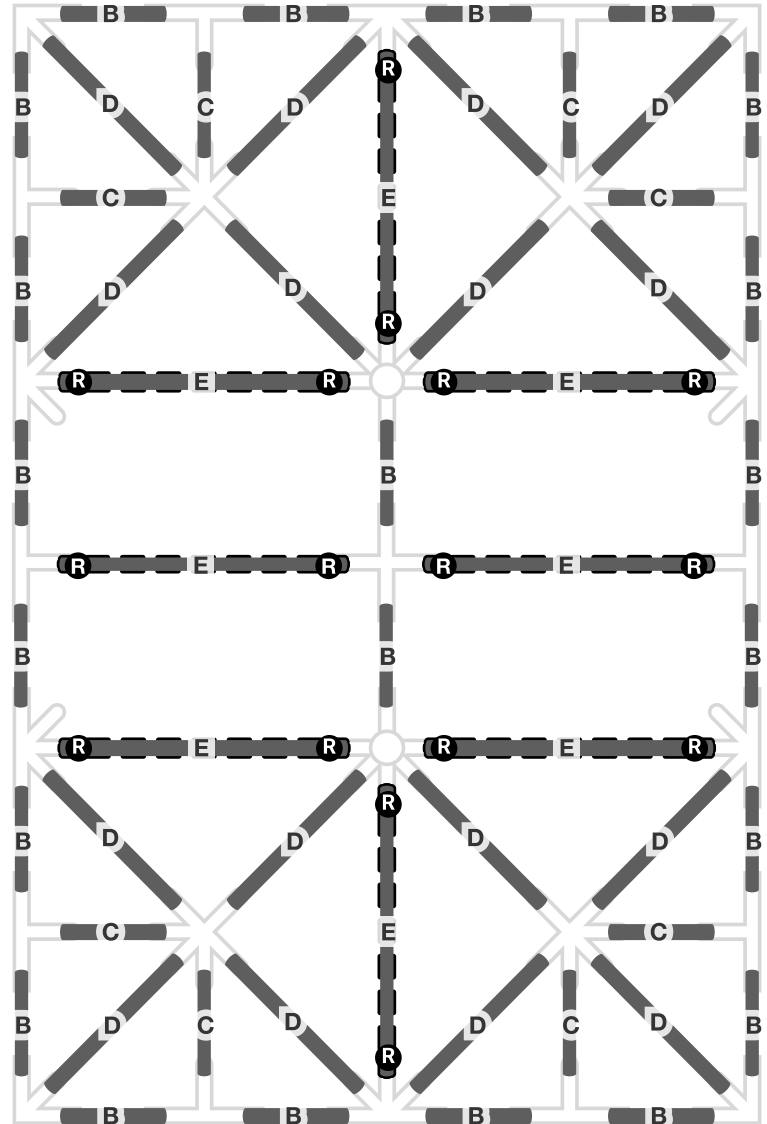

Frame Tent Double Tube Assembly and Set Up



2350 East Mason Street, Green Bay, WI

| 920.431.0938

| sales@americantent.com

| www.americantent.com

SET UP

RIVET SIDE

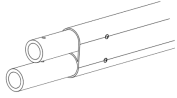

R-PIN SIDE



R-PIN



ENSURE THAT THE DOUBLE TUBE IS LINED UP PROPERLY WITH THE R-PIN HOLE FACING UP

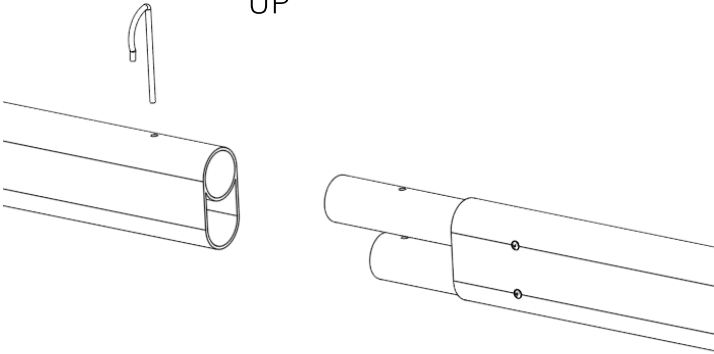

FINAL ASSEMBLY

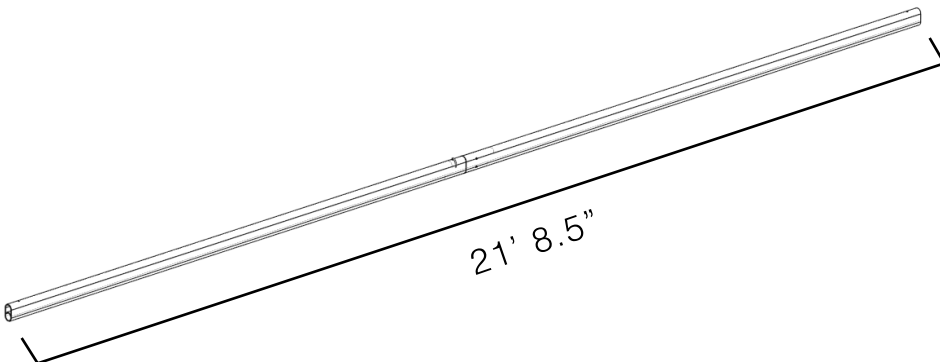

TOP VIEW

SLIDE THE RIVET SIDE OF THE DOUBLE TUBE INTO THE R-PIN SIDE

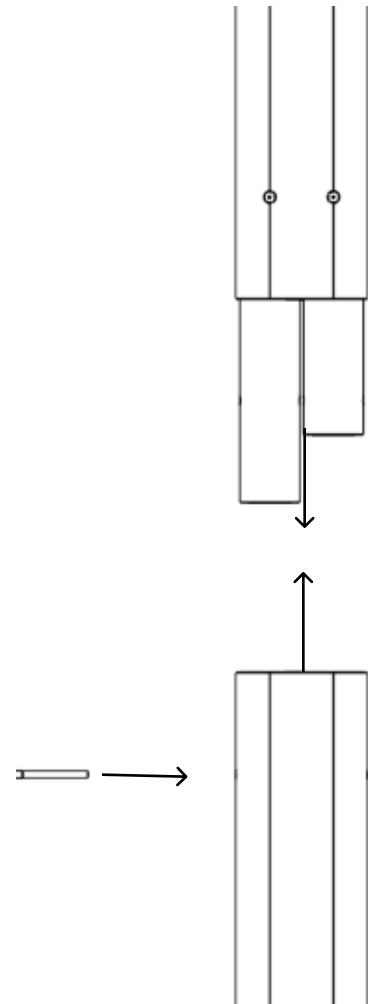

FRONT VIEW

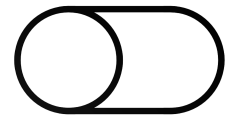

SAFETY AND MAINTENANCE

A Weather

Weather is very unpredictable; the installer or end user must use their judgment, common sense, and knowledge of conditions. The installer is responsible for anticipating weather severity for proper time and method of installation. *If inclement weather is predicted with winds that exceed 38 mph with gusts of more than 6 seconds the tent needs to be evacuated as this type of weather can lead to the tent becoming structurally unsafe. This is a temporary non-engineered structure.*

The end user should be mindful of the following conditions:

Rain

Water can collect on the tent fabric causing 'ponding' under certain conditions, especially if the tent is not installed and tensioned correctly. Ponding can destroy the tent fabric and cause poles to sink into the soil. Additionally, saturated soil can cause stakes to lose their holding power.

Lightning

It is very dangerous to be under a tent during a lightning storm. Immediately leave the tent until the chance of lightning is no longer present.

Wind

Wind can cause the tension of the tent to change by loosening ratchet assemblies, pulling stakes, or causing poles to shift or sink. It is important to do routine maintenance checks and maintain proper tension on the tent top at all times.

Snow

Tents are not designed to carry any type of snow loading. This product should not be used if snow has been allowed to accumulate.

B Site Selection



CRITICAL: Before staking, contact your local utility 811 number and have the site checked.

Scan the QR code to find your local number.

Look carefully at the factors below when selecting a site:

Soil Conditions– Adequate for anchoring

Location– Elevated, level, and clear of debris

Space– Check perimeter for space to anchor the tent

Surface– Grass, Gravel, Concrete, Asphalt, Wood

Site Access– Services and delivery can easily be achieved

Check Overhead– Look for any electrical lines or tree branches

Underground Utilities– Utilities must be located

Use the 811 service to schedule a utility locate. If staking, be aware of underground electric, gas, oil, steam, telephone, CATV, water, sewer services. Have the site checked prior to staking.

Weather– Monitor for weather conditions and evacuate if necessary

Emergency Exits– Easily accessible exit routes in case of emergency

C Fire Safety

Our tents come with an NFPA tag confirming the material meets or exceeds NFPA-701-2.

Safety Checklist:

- When building or assembling anything above shoulder height, wear a hard hat
- Steel toe boots are recommended
- Inspect the site– look for overhead and underground obstructions
- Call your local utility to have the area marked ahead of time
- Inspect all ropes and tie lines and replace/repair as needed
- Inspect all poles and fittings to make sure there are no bends or breaks
- Replace or repair any items in poor condition
- CALL 8-1-1 BEFORE DOING ANY STAKING

The installer must follow local building codes and fire regulations, and evaluate the site for proper securing and anchoring for the conditions.

D Staking

If you are using stakes to secure your tent:

Step 1

Drive a stake approximately 5' away for 7' legs, 6' away for 8' legs, and so on. Stakes should have 6" or less of the head exposed. The deeper the stake is driven, the better the holding strength. Stakes driven vertically have better holding strength than stakes driven at an angle.

Step 2

Attach a ratchet head to each stake. Straps should always go around the fittings, not the poles.

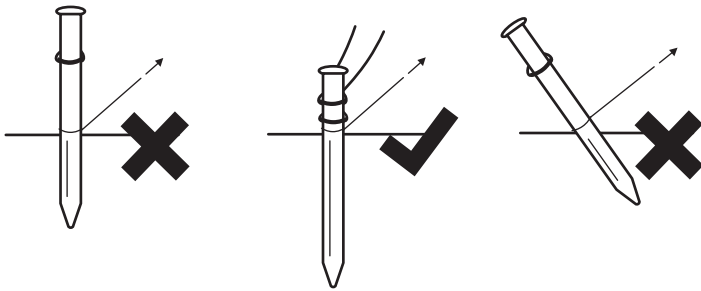

Before staking please contact your local utility 811 number and have the site checked. Please use this link to find the phone number needed by simply clicking on your state:
<https://call811.com/811-In-Your-State>

E Maintenance:

- Where applicable, do a once around the tent top and re-tension the alligator clips and straps followed by detailing (tucking the loose end of the strap into the clip)
- Check and re-tension all ratchets, straps, and cables
- Ensure stakes are in place and not pulling from ground

Caring for Your Tent:

The setup and take down process can make or break a tent--literally. Placing your tent tops directly on the ground is never a good idea. A tent on the ground is at extreme risk for pinholes, dirt, and other disasters. Protect your tent from damage with a **drop cloth**.

Handle **poles** with care. Stack them on top of each other, but be sure to not clang or scrape them together. Use common sense and treat those poles with respect.

When you are storing your tent for the **long term**, beware of extreme temperatures. Too hot and your tent can be damaged, too cold and your tent could crack. Extreme cold is especially dangerous for our clear vinyl. Freezing cold temperatures can cause it to crack. Store tents in a sheltered place where the temperature will stay above freezing.

Clean with gentle cleaners like dish soap or powder laundry detergent. Avoid bleach, abrasive chemicals, and hard brushes.

TERMS & CONDITIONS

TERMS AND CONDITIONS OF SALE

1. Terms Control/Rejection of Conflicting Terms. All sales are governed by these terms, and by placing an order, submitting payment, or providing Seller with a Purchase Order, Buyer agrees to these terms. Seller's offer to sell Buyer the Goods is conditioned on this acceptance. All other terms are rejected, including any terms included on any Purchase Orders from Buyer to Seller.
2. Payment Terms. Unless otherwise agreed in writing by Seller and Buyer, all order shall be prepaid in full before Seller ships any product subject to these Terms and Conditions (the "Goods"). If Buyer pays by check other than a cashier's check, Seller may delay shipment for a reasonable period as determined in Seller's sole discretion.
3. Taxes. Prices do not include sales, use, VAT, excise and other taxes or governmental charges with respect to the production, sale, distribution or delivery of the Goods. The final invoice amount includes all applicable taxes or governmental charges. Seller is responsible for proper remittance of all such taxes or governmental charges.
4. Shipping. Unless otherwise agreed in writing by Seller and buyer,

TERMS & CONDITIONS

- shipment terms are F.O.B. Origin, Freight Prepaid and Add. Choice of carrier shall be in Seller's sole discretion.
- Returns/Cancellations. All sales are final upon pickup or shipment from Seller's facility. Seller will not accept returns of any of the Goods except under certain circumstances as set forth in an authorized Returned Merchandise Authorization (RMA), which must include pictures of the tent purchased. RMA forms are available upon request. Seller holds sole discretion of authorization. Orders for Goods may be cancelled at any time prior to pick up or shipment from Seller's facility; provided, however, that any such cancellation shall result in a restocking fee of twenty-five percent (25%) of the original purchase price of the cancelled Order for having reserved a spot on our production schedule. This applies even for those orders that are via PO.
 - Returns. All sales are final. Seller will not accept returns of any of the Goods except under certain circumstances as set forth by an authorized RMA, which must include pictures of the tent erected. RMA forms are available upon request. Seller holds sole discretion of authorization.
 - Force Majeure. Seller will not be liable for any delay of its performance hereunder if the delay is directly or indirectly caused by or arises from fires, floods, terrorism, accidents, riots, war, government interference, embargoes, strikes, shortage of labor, materials or supplies, inadequate transportation facilities or any other cause beyond Seller's control.
 - Warranty. All tents are sold as is, and no warranties are given.
 - Damages. Any damages that occur as a result of improperly ballasted or improperly staked tents are the sole responsibility of the Buyer. Buyer acknowledges that tent must be ballasted or staked per the recommendations made by Seller. Seller will not be responsible for material, personal, or financial loss.
 - Commitment to Cure. We are committed to our workmanship and our customers. We will make right any issues with the tent top and/or parts prior to their initial use. Customers must bring any and all issues to our attention within 14 days of receipt of goods. We cannot honor requests for cure after 14 days of receipt.
 - Limitation of Damages. Seller shall not be liable for indirect, incidental, consequential, exemplary or punitive damages resulting from or arising in connection with any act or omission of Seller relating to any breach of these Terms and Conditions or relating in any way to the design, manufacture, delivery or use of the Goods. Seller's liability, regardless of grounds, shall be limited to the amount paid by Buyer for the Goods.
 - Limitation of Actions. Any statute of limitations notwithstanding, no claim shall be filed or brought against Seller for any breach of these terms and conditions after two (2) years of the date Buyer receives the Goods.
 - Installation and Service. Seller shall not be required to install, service or provide any on-site preparation or installation of any of the Goods. If Seller provides instruction to Buyer generally or specifically regarding any methods of installation, such instruction is gratuitous and is not to be considered a part of these Terms and Conditions.
 - Nature of Goods as Temporary Structures. Each of the Goods constitutes a temporary structure or part of a temporary structure that is not intended to meet any building or other codes. Buyer uses the Goods at his/her/ its sole risk.
 - Modifications. These Terms and Conditions may not be amended, modified, terminated or repudiated, in whole or in part, except in writing signed by Seller and Buyer.
 - Remedies Not Exclusive. No remedy of Seller provided herein is exclusive of any other remedy available to Seller.
 - Assignment. Buyer cannot assign any rights, duties or obligations hereunder without Seller's prior written consent.
 - Governing Law and Venue. These Terms and Conditions shall be governed by, and construed in accordance with, the laws of the State of Wisconsin, and any legal proceeding with regard to these Terms and Conditions or the Goods shall be brought in the Circuit Court for Brown County, Wisconsin. Buyer hereby waives any claims of forum non conveniens or any other similar claims.
 - Cost of Collection. Buyer shall be liable to pay Seller for all costs associated with any breach of these Terms and Conditions by Buyer, including Seller's actual attorney's fees.
 - Authority of Signers. Each person accepting these Terms and Conditions represents and warrants that he/she has been duly authorized to do so.
 - Counterparts & Facsimile Signatures. These Terms and Conditions may be signed in counterparts. Facsimile and electronic signatures shall have the same effect as originals. Placing and paying for an order online also acknowledges and agrees to these Terms & Conditions.
 - Pickup Orders: Customers may request to pick up purchased products from American Tent's facility in Green Bay, Wisconsin. Upon such request, the customer must schedule a pick-up time during American Tent's regular warehouse hours, which are 7:00 a.m. to 4:00 p.m., Monday through Thursday. Loading time will vary based on order size and method of transportation. Orders that are not picked up within five (5) business days of the scheduled pick-up date (Fridays excluded) may be subject to storage fees. Customers must mark any product shortages, damages, or other issues with the order prior to departure from American Tent's facility. The customer's signature on an American Tent acknowledgement receipt confirms that all proper products and quantities have been received and that such products are free of visible damage. Unless otherwise agreed in writing, the Customer is responsible for all product loading and providing or retaining transportation for all products placed for pick-up.

SET UP

Please know that your safety is our priority. Before setting up your tent, be sure to confirm with your local utility locating service that it is safe to set up your tent in your desired location. Be aware of potential weather conditions, and always evacuate your tent during periods of extraordinarily high winds or lightning.

1. Place the frame parts on the ground.

Put them in their approximate locations where they will be when the frame is assembled. This ensures all parts are accounted for at the beginning of your tent set up. See diagrams on pages 2-4.

2. Place pins in 6-way crowns.

- Each protrusion on the crown has two holes. One hole is closer to the center (alignment hole), and the other is further down the protrusion (placement hole).
- Place a pin in the alignment hole. The pin prevents the rafter from moving too far onto the crown.

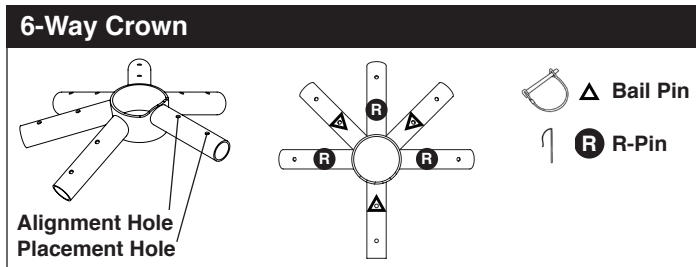

3. Connect 6-way crown to Pole D.

- Slide tubing onto the protrusion until it meets the pin.
- Align placement hole in the crown with hole in the pole and insert pin
- Remove alignment hole pin

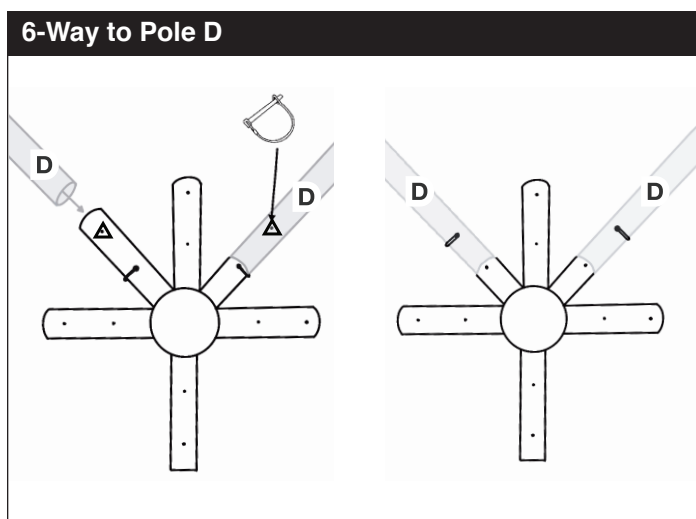

4. Connect the rest of the tubing to the 6-way crown.

6-way Crown Tubing

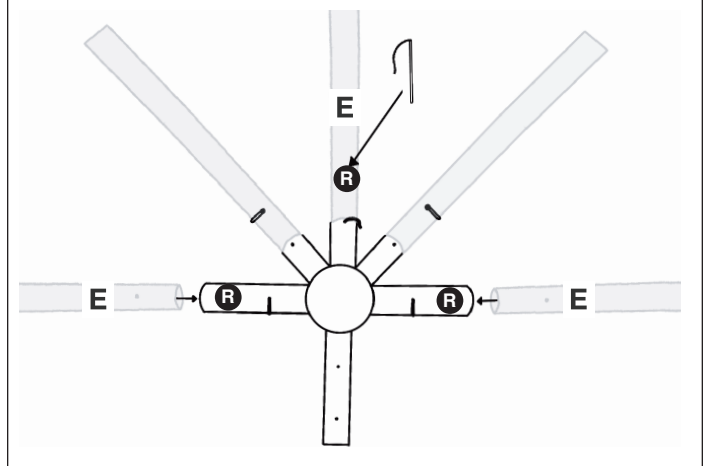

! Pro tip

While building your tent attach R-Pins in similar directions. When you lift the tent top over the frame later on, this will minimize the risk of tearing and pulling.

5. Build your frame top in sections.

Build 6-way crown sections, as shown according to your diagram. Connect mids one at a time, working across the length of the tent connecting all poles and fittings. Finish at second end bay.

End Bay Construction

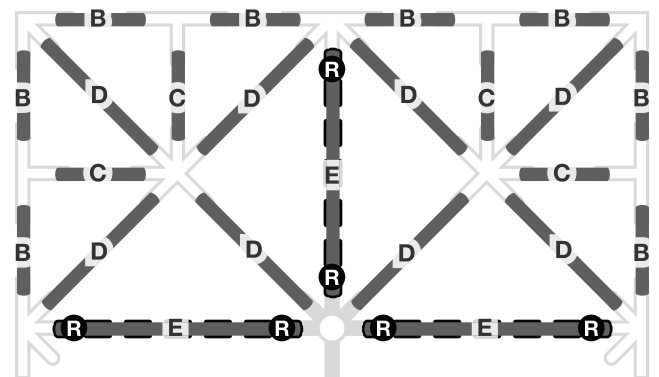

Please note: If an attachment is not marked with a R pin, use a bail pin

Frame Sections

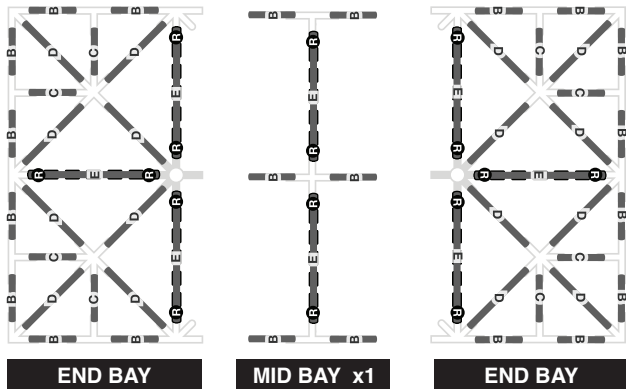

- Clip one carabiner on 40' cable to O ring on side tee. Pull cable across 40' width. Connect other end of cable to side tee on adjacent side by clipping other carabiner to O ring on fitting.

Repeat at all side tees between the 6-way crowns. Reference diagram for placement.

Cross Cable

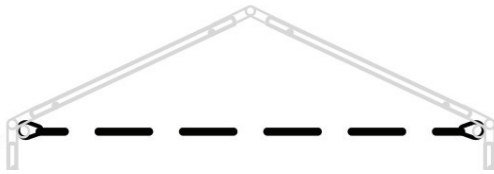

- You should now have an assembled frame top that looks like your tent's diagram.
- Loop end of each ratchet strap to fitting at each leg location.

Loop Ratchet

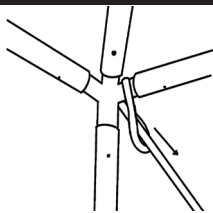

- Unroll the tent top**
 Place pieces on a drop cloth to protect the tent from dirt and abrasions. Align lace side of piece to grommet side of next piece.
- Lace tent together.**
 - Line up each section (lace at bottom) so they overlap
 - Pull first lace up through first small grommet. Pull

- second lace up through second grommet and then pull through the loop of the first lace and so on.
- Tie off at end to secure whole lace line
- Repeat to secure all other lace lines
- Fold the rain flap over connecting velcro-like material on either side of the laces

Lacing Tent

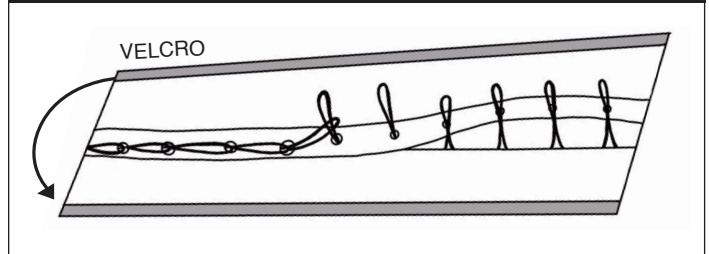

- Pull tent top over the frame, lifting up on the fabric to create air cushion under the tent top.
- Center tent top on frame by hiding the seams behind hip rafters. Loosely fasten the alligator straps at each side of the corners around the perimeter tubing and at each laceline to secure the tent top.
- Attach the base plates to legs securing with a pin.
- Lift the downwind 100' side of the frame, keeping it level along the length of the tent to avoid bending in the poles.**
 No matter what the wind conditions are, always lift the downwind side of the tent first. This prevents the wind from catching the tent. Do not lift one corner at a time. Instead, lift up the entire side.
- Attach all leg poles to the lifted side.

Lifting Tent

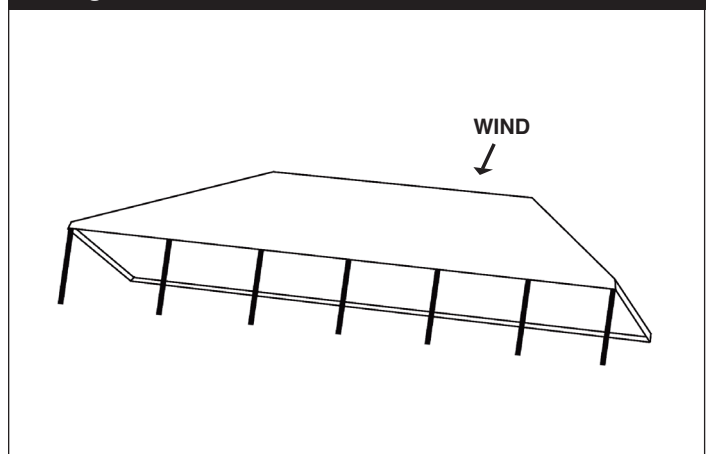

16. Place stakes 5' out from each leg; drive stakes into the ground so that ideally 6" or less of the stake shows.

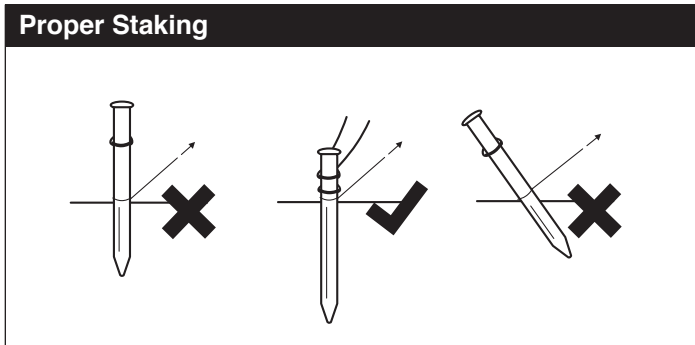

17. Attach ratchet straps to the stakes loosely.

Attach ratchet buckle with loop strap to stakes by turning the 6" loop at the end of the ratchet inside out and pull strap through the loop. This will create a slipknot to pull tight over the stake. Take loop strap attached to tent and pull it through reel bars slot of ratchet. Keep ratchet buckle handle facing up at all times. Pull other loop strap back towards tent approximately 18 inches.

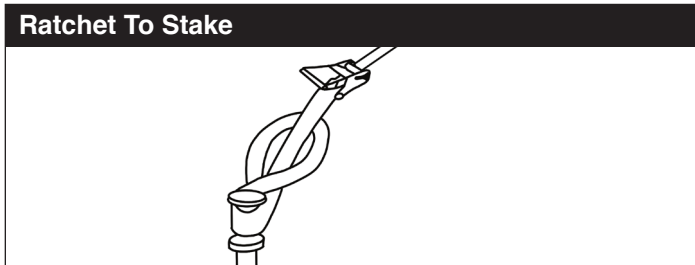

18. Fasten the rest of the alligator straps around perimeter tubing. Do this by tugging on the valence to keep the material taut and firmly pulling the straps. Slide excess strap through the metal slide on the alligator clip.

Pulling too hard will cause undue wear and tear as well as wrinkling in the tent top fabric.

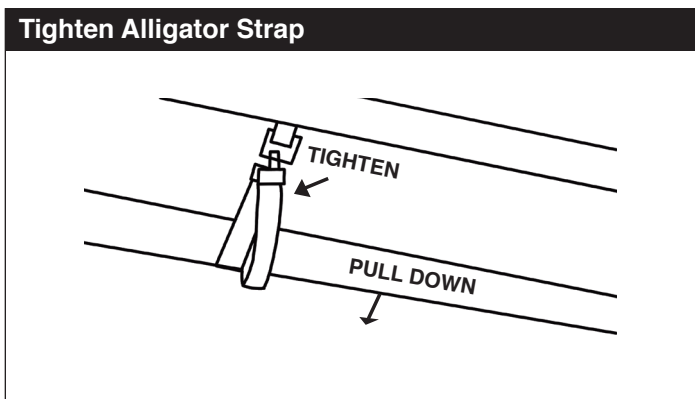

19. Raise the other side of the tent and secure on remaining legs.

20. Tighten ratchet straps by holding strap with one hand and cranking ratchet handle with the other.

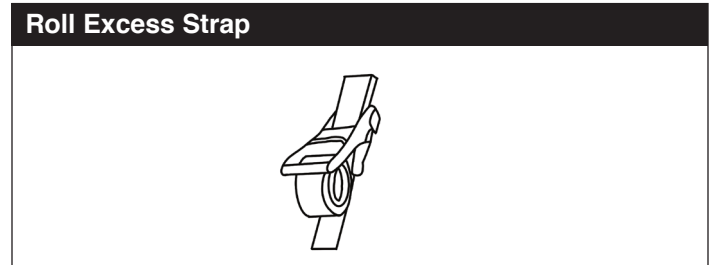

21. Roll excess ratchet straps and secure into the ratchet buckle.

22. Congratulations! Your tent should now be complete.

For further assembly of additional accessories and attachments please see page 12

TAKE DOWN

1. Loosen ratchet strap assemblies.
2. Remove every other side leg. Leave no more than 40' of tent unsupported to prevent bending.
3. Unfasten all alligator straps except the two at each corner and ones at lace line.
4. Remove 2 corner legs from one side and carefully set the tent frame on ground.
5. Repeat with opposite side.
6. Unfasten rest of the straps till all are completely disconnected.
7. Roll out your drop cloth.
8. Remove the tent top from the frame.
9. Unlace your tent top.
 - a. Separate velcro-like fabric that connects tents together. Undo rain flap.
 - b. Untie knot and unlace the tent top section while disconnecting the rain flap.
10. Fold and roll the tent top pieces as tight as possible. For the longevity of your tent, do not stand or walk on top of the tent top. Use a fan fold or a z-fold for best results.
11. Fold and roll up the drop cloth.
12. Disassemble all of the cross cables, corner, side tee, and center crown fittings by removing the pins and sliding the tubing off fittings. Work from perimeter of frame inward.
13. Remove all stakes.
14. Congratulate your team for a job well done!

CARE & MAINTANCE

How to Store a Tent

The first thing you need to know about storing your tent is summed up in two words: DROP CLOTH. You need a drop cloth.

Why do you need a drop cloth for your tent? Drop cloths reduce the likelihood of:

- Pinholes--you know as well as we do that tiny pinholes make huge problems
- Tears--the easiest way to kiss your investment goodbye
- Dirt and grass stains
- Mystery residue from a surface you thought was safe

1. Bag It

If your tent was supplied with a bag, put your tent top back into the bag. This will keep it protected from hazardous situations.

Storing Sidewalls

While you should still use your drop cloth when setting up and taking down sidewalls, it isn't as critical. After

all, rain won't come pouring in through a small rip or tear in your sidewalls. Even so, handle with care. Rolling your sidewalls is the best way to store them and prevent damage.

How to Store Tent Poles

We've seen some inspirational systems for tent pole storage--beautiful structures designed exclusively to cradle poles while they wait for their next assignment. But basically all you have to do is make sure you handle them with care.

Cleaning

Always put away your tent in a clean and dry condition. Make sure the cleaners you use are safe for your tent material and that they are completely wiped down before you roll up your tent and put it back in its bag. Use a gentle cleaner such as dish soap or powder laundry detergent and completely avoid bleach, abrasive chemicals, and hard brushes.

ADDITIONAL PRODUCT ASSEMBLY

SIDEWALLS

1. Terminate sidewall rope at one end with sidewall rope clamp, if included
2. Carefully unroll the sidewall so that it is a long, fan folded piece
3. Pick up the sidewall and carry on one shoulder while clipping every third clip with the opposite arm
4. Make sure the open side of the clips are facing in towards you

Sidewall Clips

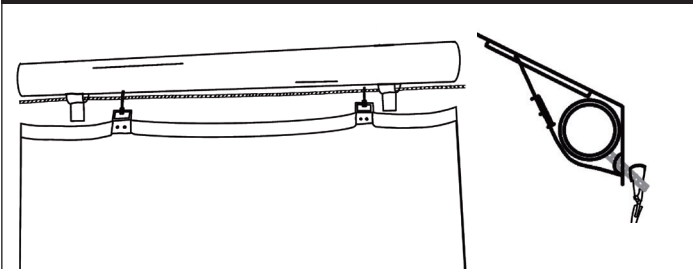

5. Once every third clip has been attached, go back and clip the rest

6. Use clips to either secure around the pole or attach to next sidewall section

Sidewall Clips

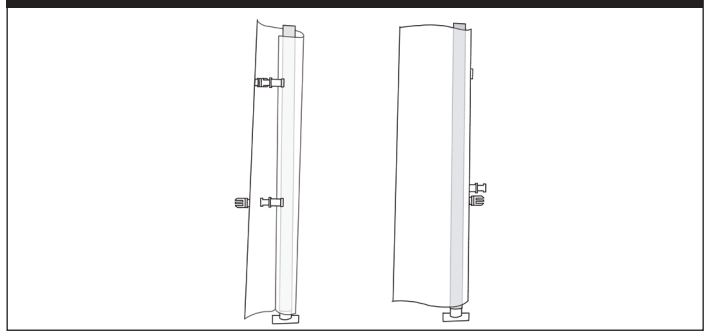

7. Fanfolding is best for storing your sidewalls; be sure they are clean and dry before fan folding them and storing them for next time

Need Help?

Check out our Youtube channel for instructional videos and how-tos!
Or give us a call at 920-542-6282



RAIN GUTTER

1. Take two tents and move them rightly 8" apart from each other

Leg Spacing

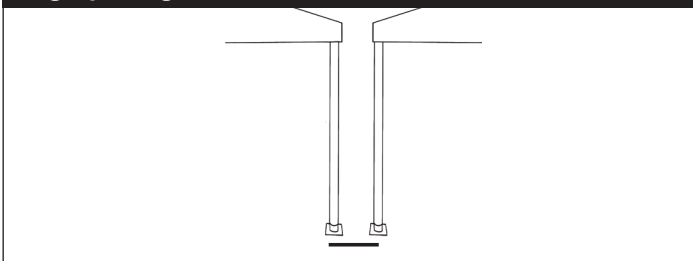

2. Similar to a sidewall, the rain gutter will attach to the sidewall rope.
3. Take the clips of one side and attaching them to the rope located on the underside of the first tent.

4. After attaching the first side, take the second side and repeat on the underside of the second tent

Rain Gutter

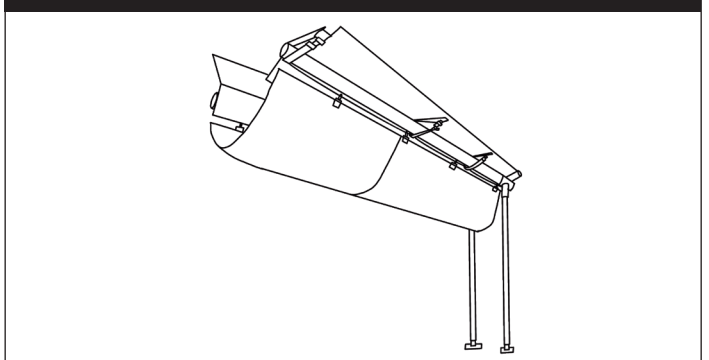

40x60x7 Frame Tent Cable Hardware & Staking Package



2350 East Mason Street, Suite 8, Green Bay, WI 54302 | 920.431.0938 | sales@americantent.com | www.americantent.com

ANCHORING

- 
40x  Giffy Barrel
PUR-GIF-BRL
- 
20x  Double Giffy Plate
PUR-GIF-PLA-DBL
- 
20x  Double Hardware Kit
KIT-HDW-DBL
- 
40x  Ratchet Strap
KIT-RAT-2N

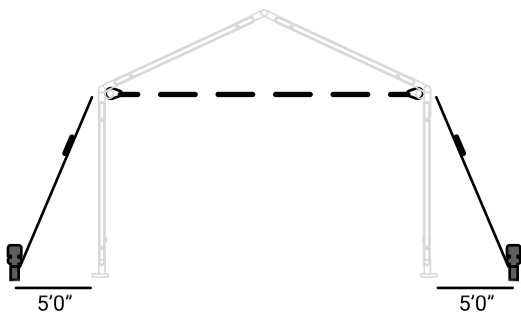
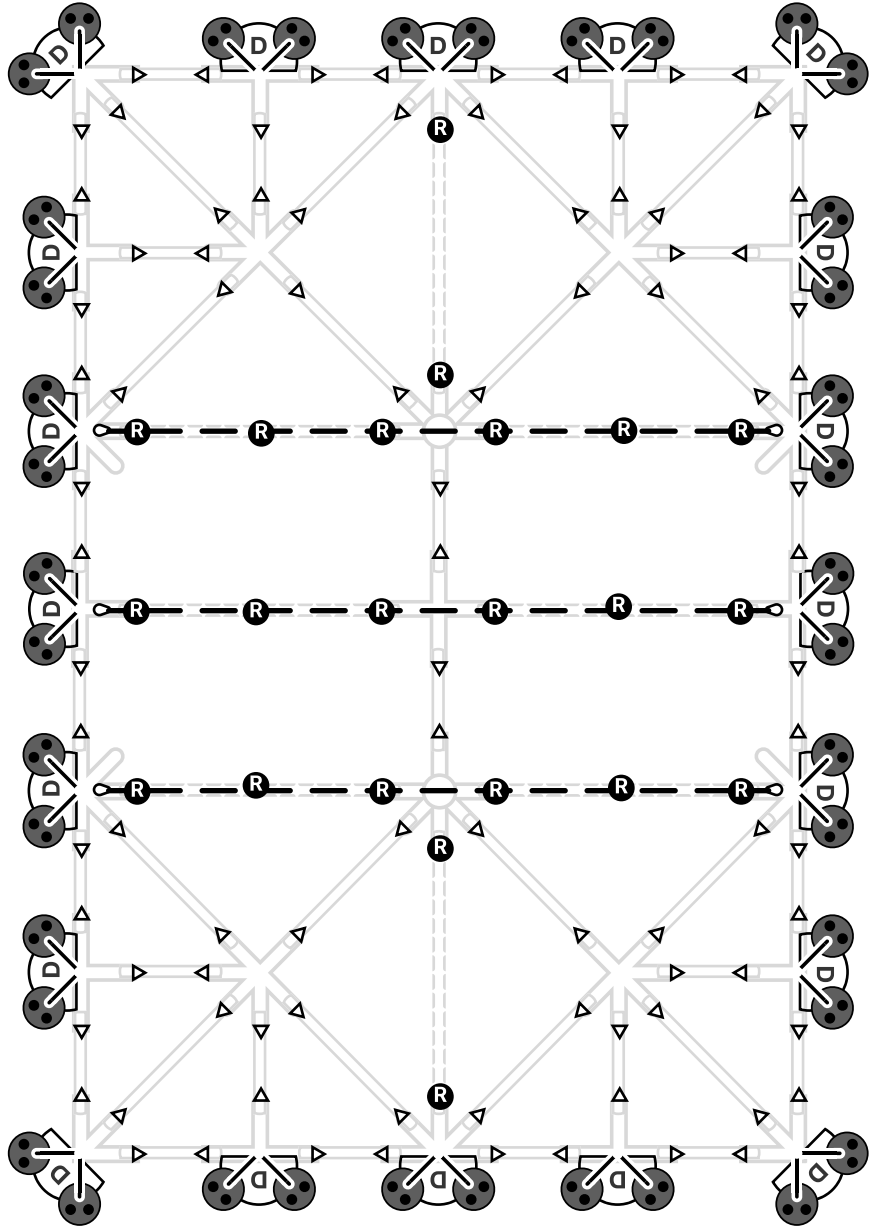

ADDITIONAL PRODUCT ASSEMBLY

GIFFY BALLASTS

1. Turn the barrel upside down to connect the mounting plate.

Giffy Parts

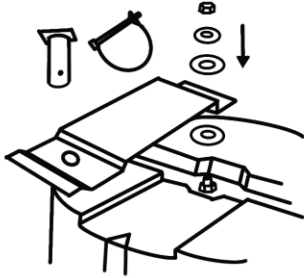

2. Assemble the hardware for the Giffy barrel using the following sequence:

- Place a large washer over the nut and bolt.
- Place the plate over the washer.
- Place another large washer followed by a smaller washer, then place and tighten the nut.
- Flip the barrel right side up and insert the base plate through the hole in the plate.
- Place a pole over the base plate that has been inserted into the plate. Put pin through pole and base plate and secure

Base Plate

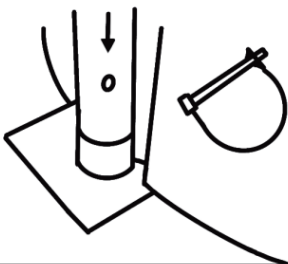

Ratchet Loop

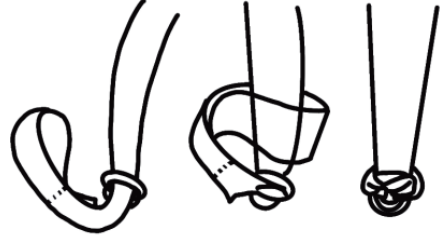

3. Connect the strap to the eye bolt in the bottom of the barrel.

- Pull looped end of the strap through the eye bolt. Take the other end of the strap and pull it all the way through the loop. Pull long end tight to secure strap to eye bolt.
- Pull the strap through the cover slot.

Cover Slot



4. Connect the opposite end of the strap to the top of the fitting. Put all ratchet straps around the fittings, never around the tent frame pipes. This forms a strong triangle.

5. Fill the barrel with water.